

# vtech®

## Complete user's manual

[www.vtechphones.com](http://www.vtechphones.com)



Models:  
DS6641/DS6641-2

 **Bluetooth®**

**DECT 6.0**

# Congratulations

on purchasing your new VTech product. Before using this telephone, please read **Important safety instructions** on page 87 of this manual.

This manual has all the feature operations and troubleshooting necessary to install and operate your new VTech telephone. Please review this manual thoroughly to ensure proper installation and operation of this innovative and feature rich VTech product. For support, shopping, and everything new at VTech, visit our website at [www.vtechphones.com](http://www.vtechphones.com). In Canada, please visit [www.vtechcanada.com](http://www.vtechcanada.com).



The ENERGY STAR<sup>®</sup> program ([www.energystar.gov](http://www.energystar.gov)) recognizes and encourages the use of products that save energy and help protect our environment. We are proud to mark this product with the ENERGY STAR<sup>®</sup> label indicating it meets the latest energy efficiency guidelines.



Telephones identified with this logo have reduced noise and interference when used with most T-coil equipped hearing aids and cochlear implants. The TIA-1083 Compliant Logo is a trademark of the Telecommunications Industry Association. Used under license.

**Register online to get an additional 3-month warranty!**  
**Visit [www.vtechphones.com](http://www.vtechphones.com).**



## Registration

Register your product online for enhanced warranty support.



## Product news

Learn about the latest VTech products.

# Table of contents

<b>Getting started</b> .....	<b>1</b>	Call waiting on the home line.....	31
Parts checklist .....	1	Make a cell call .....	31
Telephone base and handset charger installation .....	2	Predial a cell call.....	32
Handset battery installation .....	3	Answer a cell call.....	32
Handset battery charging .....	4	End a cell call .....	33
Installation options.....	5	Call waiting on the cell line .....	33
Tabletop to wall mount installation .....	5	Answer a cell call while on a home call .....	33
Wall mount to tabletop installation.....	7	Cell phone voicemail .....	33
Are you a new cable or VoIP subscriber? ...	8	Answer a home call while on a cell call .....	34
Did you subscribe to voicemail service from your telephone service provider?....	8	Speakerphone .....	34
Telephone base layout .....	9	Volume control.....	34
Handset layout.....	12	Mute.....	35
<b>Bluetooth</b> .....	<b>14</b>	Temporary ringer silencing.....	35
Introducing Bluetooth.....	14	Redial .....	36
Glossary of terms .....	16	Temporary tone dialing.....	37
Bluetooth setup.....	17	Check voicemail .....	38
Add a cell phone.....	18	Chain dialing.....	38
Review the cell devices list.....	19	Transfer a call.....	39
Auto connection.....	19	Find handset.....	40
Download directory.....	20	Web address .....	40
<b>Telephone settings</b> .....	<b>21</b>	<b>Multiple handset use</b> .....	<b>41</b>
Using the menu .....	21	Join a call in progress.....	41
Handset ringer volume .....	22	Intercom.....	42
Telephone base ringer volume .....	22	Answer an incoming call during an intercom call.....	44
Ringer tone .....	23	<b>Directory</b> .....	<b>45</b>
Set date and time .....	24	About the directory .....	45
LCD language.....	25	Add a directory entry .....	46
Voicemail number.....	26	Review directory entries .....	48
Clear voicemail indicators.....	27	Alphabetical search .....	48
Key tone .....	27	Dial a directory entry.....	49
Home area code .....	28	Edit a directory entry.....	49
Dial mode .....	28	Delete directory entries.....	50
Quiet mode .....	29	Speed dial.....	51
<b>Telephone operation</b> .....	<b>30</b>	Assign a speed dial number .....	51
Make a home call .....	30	Reassign a speed dial number.....	51
Predial a home call .....	30	Dial a speed dial number.....	52
Answer a home call .....	30	Delete a speed dial number.....	52
End a home call.....	31		

# Table of contents

<b>Caller ID</b> .....	<b>53</b>	<b>Appendix</b> .....	<b>71</b>
About the caller ID log .....	53	Expand your telephone system .....	71
Information about caller ID with call waiting .....	53	Add and register a handset .....	71
Caller ID log .....	54	Replace a handset.....	72
Missed call indicator .....	55	Screen messages.....	73
Review the caller ID log.....	55	Handset and telephone base indicators .....	75
View dialing options.....	56	Handset battery .....	77
Dial a caller ID log entry .....	56	Troubleshooting.....	78
Save a caller ID log entry to the directory....	57	Important safety instructions.....	87
Delete caller ID log entries .....	57	Precautions for users of implanted cardiac pacemakers.....	88
Caller ID log screen messages.....	58	Operating range.....	88
<b>Answering system settings</b> .....	<b>59</b>	ECO mode.....	88
Answering system .....	59	Maintenance.....	89
Announcement .....	59	About cordless telephones .....	90
Record your own announcement.....	59	The RBRC <sup>®</sup> seal.....	90
Play your announcement.....	60	Limited warranty .....	91
Delete your announcement .....	60	FCC, ACTA and IC regulations .....	93
Answer on/off.....	61	Technical specifications.....	95
Call screening.....	62	<b>Index</b> .....	<b>96</b>
Number of rings .....	62		
Remote access code .....	62		
Message alert tone .....	63		
Message recording time .....	63		
<b>Answering system operation</b> .....	<b>64</b>		
Answering system and voicemail .....	64		
Using the answering system and voicemail together.....	65		
Message capacity.....	65		
New message indication.....	65		
Call screening .....	66		
Call intercept.....	66		
Temporarily turn off the message alert tone .....	66		
Message playback.....	67		
Delete all old messages .....	68		
Record, play and delete memos.....	69		
Remote access.....	70		



# Getting started

## Parts checklist

Your telephone package contains the following items. Save your sales receipt and original packaging in case it is necessary to ship your telephone for warranty service.



Telephone base

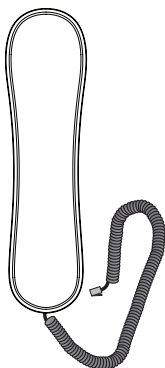

Corded handset



Cordless handset  
(1 for DS6641)  
(2 for DS6641-2)

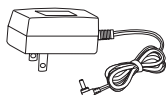

Telephone base adapter

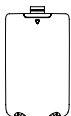

Battery compartment cover  
(1 for DS6641)  
(2 for DS6641-2)



Batteries  
(1 for DS6641)  
(2 for DS6641-2)

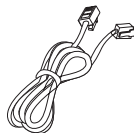

Telephone line cord

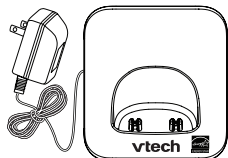

Handset chargers and  
charger adapters  
(1 for DS6641)  
(2 for DS6641-2)

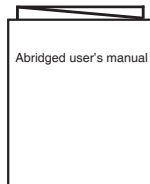

Abridged user's manual

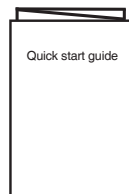

Quick start guide

### note

To purchase replacement batteries or power adapters, visit our website at [www.vtechphones.com](http://www.vtechphones.com) or call 1 (800) 595-9511. In Canada, go to [www.vtechcanada.com](http://www.vtechcanada.com) or dial 1 (800) 267-7377.

# Getting started

## Telephone base and handset charger installation

Install the telephone base and handset chargers as shown below.

Make sure that the electrical outlet is not controlled by a wall switch.

If you subscribe to digital subscriber line (DSL) high-speed Internet service through your telephone line, you must install a DSL filter between the telephone line cord and the telephone wall jack. The filter prevents noise and caller ID problems caused by DSL interference. Contact your DSL service provider for more information about DSL filters.

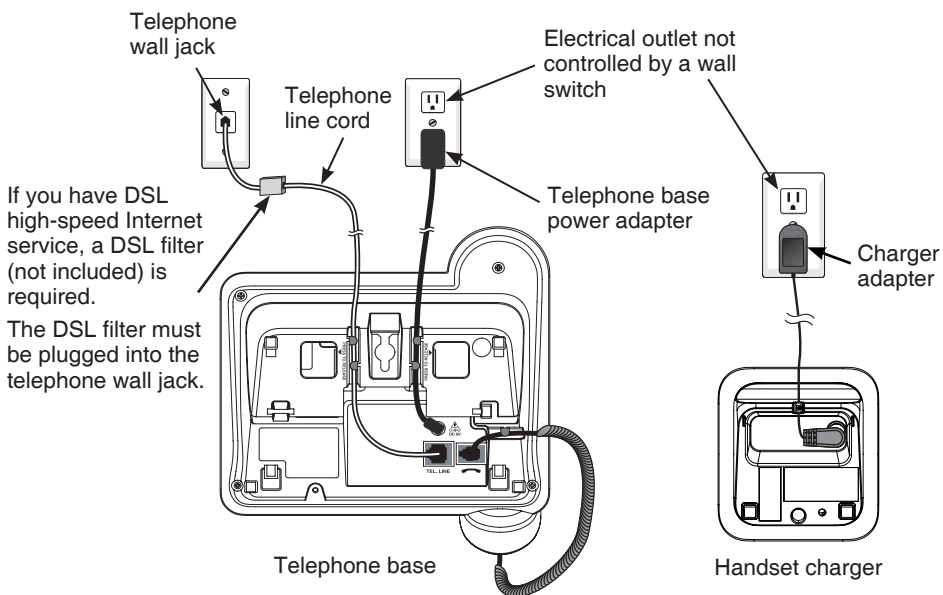

### note

- This telephone provides minimal functionality during a power outage. When the AC power is not available, many telephone features do not function. The telephone uses power from the telephone line to enable you to make and answer calls using only the corded handset and dialing keys. However, when another telephone on the same line is being used simultaneously, there might not be sufficient power to use your telephone in the event of a power failure.
- Even if you do not subscribe to any conventional telephone service, you can still use the cell line alone without plugging in a telephone line cord.

### CAUTION:

If you subscribe to telephone service from a cable company or a VoIP service provider, contact your cable/VoIP service provider for more information.

# Getting started

## Handset battery installation

Install the battery as shown below.

1. Plug the battery connector securely into the socket inside the handset battery compartment, matching the orientation of the engraved label.

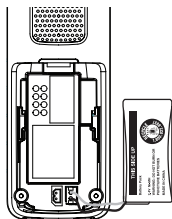

2. Place the battery with the label **THIS SIDE UP** facing up and the wires inside the battery compartment.



3. Align the cover flat against the battery compartment, then slide it towards the center of the handset until it clicks into place.



4. Place the handset in the handset charger to charge. The **CHARGE** light is on when the handset is charging.

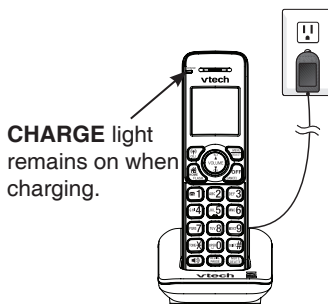

- note**
- If the handset will not be used for a long time, disconnect and remove the battery to prevent possible leakage.
  - To purchase replacement batteries, visit our website at [www.vtechphones.com](http://www.vtechphones.com) or call 1 (800) 595-9511. In Canada, go to [www.vtechcanada.com](http://www.vtechcanada.com) or dial 1 (800) 267-7377.

### IMPORTANT:

Check for a dial tone by pressing **HOME**. If you hear a dial tone, the installation is successful.

### If you do not hear a dial tone:

- Make sure the installation procedures described above are properly done.
- It may be a wiring problem. If you have changed your telephone service to digital service from a cable company or a VoIP service provider, the telephone line may need to be rewired to allow all existing telephone jacks to work. Contact your cable/VoIP service provider for more information.



# Getting started

## Handset battery charging

Once you have installed the battery, the screen indicates the battery status (see the table below). If necessary, place the handset in the handset charger to charge the battery. For best performance, keep the handset in the handset charger when not in use. The battery is fully charged after 11 hours of continuous charging. See the table on page 77 for battery operating times.

If the screen is blank or displays **Put in charger**, you need to charge the handset without interruption for at least 30 minutes to give the handset enough charge to use for a short time. When the battery is low, the handset displays **Low battery** along with a flashing  icon. If you are on a call in low battery mode, the handset plays short beeps to alert you.

The following table summarizes the battery charge indicators and actions to take.

Battery indicators	Battery status	Action
The screen is blank, or displays <b>Put in charger</b> and  flashes.	The battery has no or very little charge. The handset cannot be used.	Charge without interruption (about 30 minutes).
The screen displays <b>Low battery</b> and  flashes.	The battery has enough charge to be used for a short time.	Charge without interruption (about 30 minutes).
The screen displays <b>HANDSET X</b> .	The battery is charged.	To keep the battery charged, place it in the handset charger when not in use.

**note** If you place the handset in the handset charger without installing a battery, the screen displays **NO BATTERY**.

After you install your telephone or power returns following a power outage, the handset will prompt you to set the date and time. For instructions, see **Set date and time** on page 24. To skip setting, press **CANCEL**.

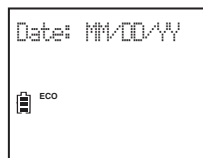

# Getting started

## Installation options

Your telephone base is ready for tabletop use. If you want to mount your telephone on a wall, swivel the wall mount bracket down to connect with a standard dual-stud telephone wall mounting plate. If you do not have this mounting plate, you can purchase one from many hardware or consumer electronics retailers. You may need a professional to install the mounting plate.

### Tabletop to wall mount installation

1. Unplug the power adapter and telephone line from the wall outlets. Remove the power adapter and telephone line from the grooves.

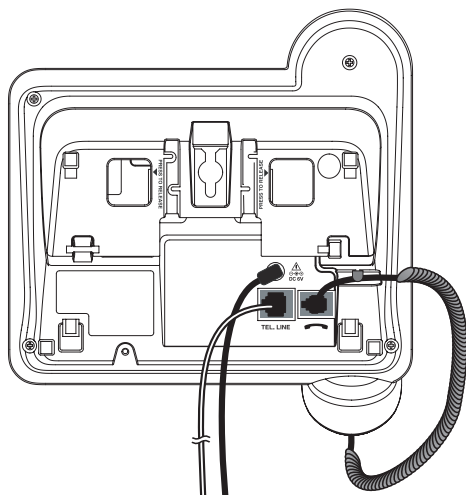

2. Squeeze the tabs on the wall mount bracket as the arrows indicated below. Swivel the wall mount bracket down.

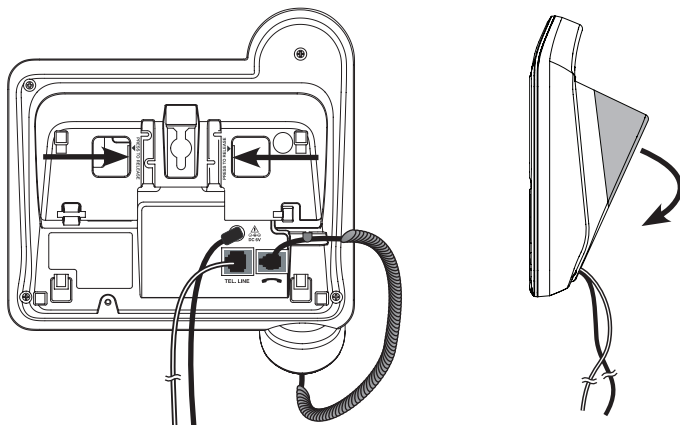

# Getting started

## Installation options

3. Route the telephone line cord through the cavity and leave a few inches for plugging into the telephone wall jack. Press the wall mount bracket onto the telephone base and click it into place.

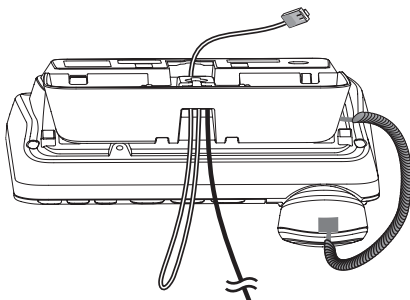

4. Put the corded handset aside. Press down the switch hook and remove the handset tab from the slot. Rotate the handset tab by 180 degrees. Press down the switch hook and then replace the handset tab to its slot.

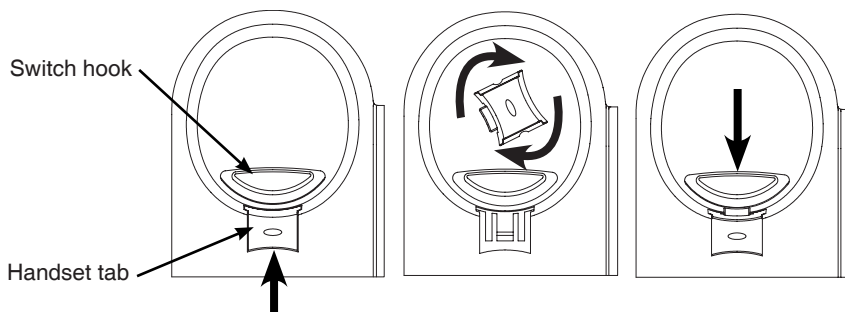

5. Plug the power adapter and telephone line into the wall outlets. Align the holes on the wall mount bracket with the standard wall mounting plate and slide the telephone down until it locks securely. Bundle the telephone line cord and power adapter cord neatly with twist ties. Put the corded handset back on the telephone base.

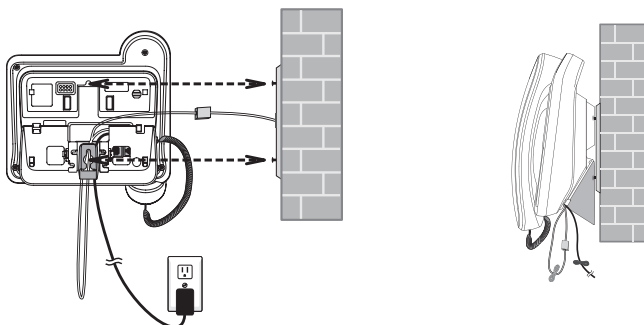

# Getting started

## Wall mount to tabletop installation

1. Remove the telephone base from the wall.
2. If necessary, untie the bundled telephone line cord and power adapter cord.
3. Pull the wall mount bracket to detach it from the telephone base. Swivel it upwards and then press onto the telephone base until it clicks into place.

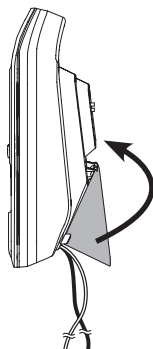
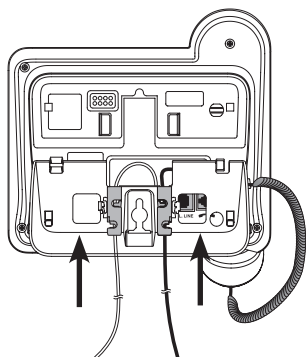

Wall mount position

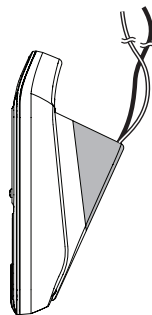

Tabletop position

4. Press down on the switch hook and slide the handset tab upwards to remove it from the slot. Rotate the handset tab by 180 degrees. Press down the switch hook and then replace the handset tab to its slot.

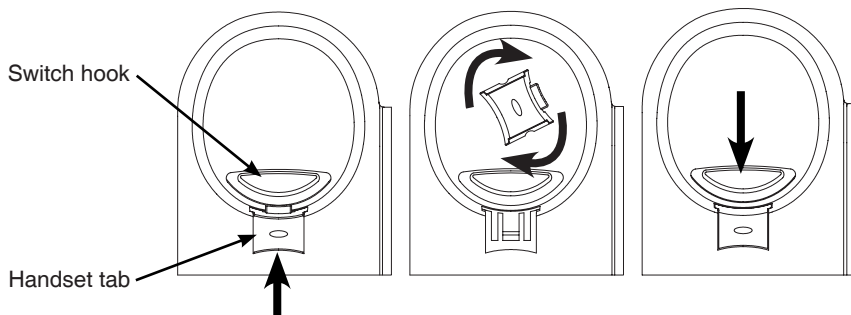

# Getting started

## Are you a new cable or VoIP subscriber?

If your answer is **yes**, the existing telephone jacks in your home may no longer work. Your cable/VoIP service provider uses a different connection, separate from your old traditional telephone service, to connect the modem/router/terminal adapter installed in your home.

To allow all existing telephone jacks to work, contact your telephone service provider for solutions, such as rewiring services (fees may apply).

If your answer is **no**, your existing telephone jacks will continue to work as normal.

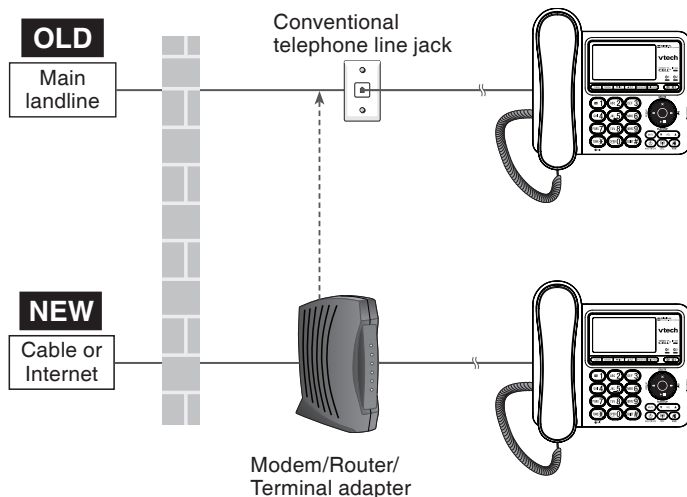

## Did you subscribe to voicemail service from your telephone service provider?

Your telephone has a built-in answering system and supports voicemail feature offered by your telephone service provider (subscription is required, and fees may apply). Refer to **Answering system and voicemail** on page 64 for more details.

### To use the built-in answering system:

You may see this online Complete user's manual on how to record your outgoing announcement, retrieve messages and other related operations. You may also refer to the Abridged user's manual provided in your product package for abbreviated instructions.

### To use the voicemail:

To retrieve your voicemail messages, you typically dial an access number provided by your telephone service provider, and then enter a security code. Contact your telephone service provider for instructions on how to configure the voicemail settings and listen to messages.



# Getting started

## Telephone base layout

### ▼CID

- Press to review the caller ID log when the phone is not in use (page 55).
- Press to scroll down while in a menu, or in the directory, caller ID log or redial list.
- Press to move the cursor to the left when entering numbers or names.

### CANCEL

- Press to silence the base ringer temporarily while the phone is ringing (page 35).
- Press and hold to erase the missed call indicator when the phone is not in use (page 55).
- Press to return to the previous menu, or press and hold to return to idle mode, without making changes (page 21).

### FLASH

- Press to answer another incoming call during a call on the same line (page 31 and page 33).

### REDIAL/PAUSE

- Press repeatedly to review the redial list (page 37).
- Press and hold to insert a dialing pause while dialing or entering a number (page 30 and page 46).

### 📶 1 / 📶 2

- Press to pair or replace a cell phone (page 18).

### 📶 1 and 📶 2 lights

- On when the telephone base is paired and connected with a Bluetooth cell phone (page 18).
- Blinks when the telephone base is pairing and connecting with a Bluetooth cell phone (page 18).



- Press to review the directory when the phone is not in use (page 48).
- Press to scroll up while in a menu, or in the directory, caller ID log or redial list.
- Press to move the cursor to the right when entering numbers or names.

### MENU/SELECT

- Press to show the menu (page 21).
- While in a menu, press to select an item or save an entry or setting (page 21).

### IN USE light

- On when the phone is in use, or when the answering system is answering an incoming call.
- On when a handset is being registered.
- Flashes when there is an incoming call.
- Flashes when handsets are being deregistered.
- Flashes when another telephone on the same line is in use.

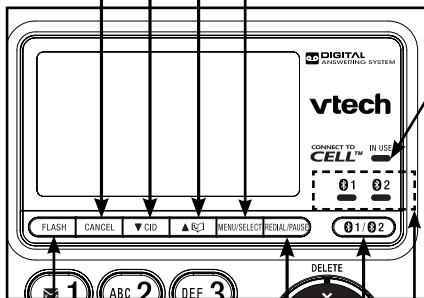

# Getting started

## Telephone base layout

### 1

- While reviewing a caller ID log entry, press repeatedly to add or remove 1 in front of the telephone number before dialing or saving it in the directory (page 56).
- Press and hold to set or dial your voicemail number (page 26 and page 38).

### TONEX

- Press to switch to tone dialing temporarily during a call (page 37).

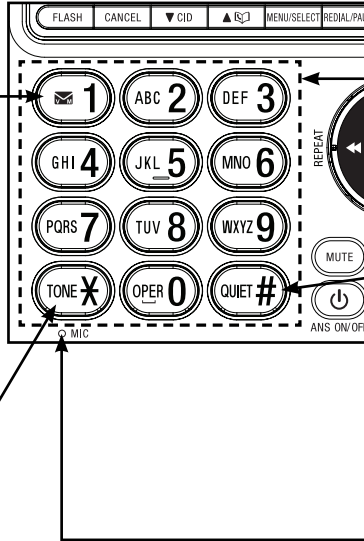

### Dialing keys

- Press to enter numbers or characters.
- Press to answer an incoming call (page 30 or page 32).

### QUIET#

- Press and hold to set and turn on the quiet mode, or turn it off (page 29).
- Press repeatedly to show other dialing options when reviewing a caller ID log entry (page 56).

### MIC

- Microphone.

### MUTE

- Press to mute the microphone during a call (page 35).
- Press to silence the base ringer temporarily while the phone is ringing (page 35).

### CELL

- Press to make, answer or end a cell call (page 31, page 32 or page 33).

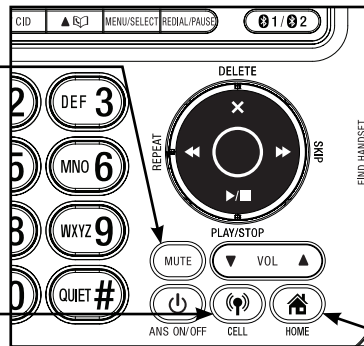

### FIND HANDSET

- Press to page all idle handsets when the telephone base is not in use (page 40).

### HOME

- Press to make, answer or end a home call (page 30 or page 31).

# Getting started

## Telephone base layout

### ◀/REPEAT

- Press once to repeat the playing message (page 67).
- Press twice to play the previous message (page 67).

### ▶/PLAY/STOP

- Press to start or stop message playback (page 67).
- Flashes when there are new messages or memos in the answering system.
- Press to temporarily turn on/off call screening (page 66).

### ⏻/ANS ON/OFF

- Press to turn the built-in answering system on or off (page 61).

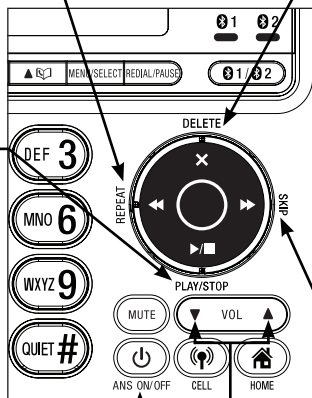

### X/DELETE

- Press to delete the playing message or announcement (page 67 or page 60).
- Press to delete the displayed entry while in the directory, caller ID log or redial list (page 37, page 50 and page 57 respectively).
- Press to delete digits or characters while using the dialing keys.

### ▶/SKIP

- Press to skip to the next message during message playback (page 67).

### ▼ VOL ▲

- Press to adjust the listening volume during a call or message playback (page 34 or page 67).
- Press to adjust the telephone base ringer volume when the base is not in use (page 22).

# Getting started

## Handset layout

### CHARGE light

- On when the handset is charging in the handset charger (page 3).

### /▲/VOLUME

- Press to review the directory when the phone is not in use (page 48).
- Press to scroll up while in a menu, or in the directory, caller ID log or redial list.
- While entering names or numbers, press to move the cursor to the right.
- During a call or message playback, press to increase the listening volume (page 34 or page 67).

### /CELL

- Press to make or answer a cell call (page 31 or page 32).
- Press to answer an incoming cell call when you hear a call waiting alert (page 33).

### /HOME/FLASH

- Press to make or answer a home call (page 30).
- Press to answer an incoming home call when you hear a call waiting alert (page 31).

### 1

- While reviewing a caller ID log entry, press repeatedly to add or remove 1 in front of the telephone number before dialing or saving it in the directory (page 56).
- Press and hold to set or dial your voicemail number (page 26 and page 38).

### tone

- Press to switch to tone dialing during a call if you have pulse service (page 37).

### 

- Press to make a home line call using the handset speakerphone (page 30).
- Press to answer a call using the handset speakerphone (page 30 and page 32).
- During a call, press to switch between the handset speakerphone and the handset earpiece (page 34).

### REDIAL/PAUSE

- Press repeatedly to view the last 10 numbers dialed (page 36).
- Press and hold to insert a dialing pause while dialing or entering numbers (page 30 and page 46).

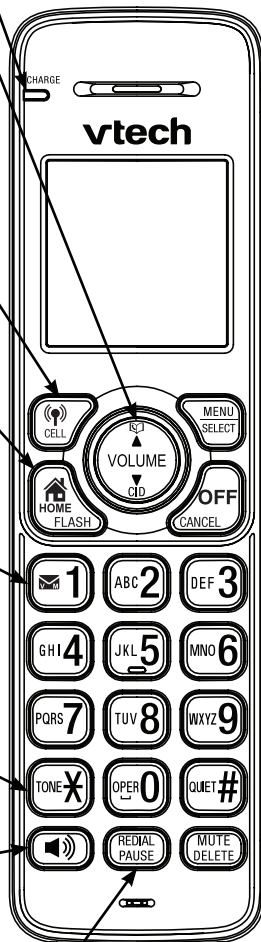

# Getting started

## Handset layout

### CID/▼/VOLUME

- Press to review the caller ID log when the phone is not in use (page 55).
- Press to scroll down while in a menu, or in the directory, caller ID log or redial list.
- While entering names or numbers, press to move the cursor to the left.
- During a call or message playback, press to decrease the listening volume (page 34 or page 67).

### MENU/SELECT

- Press to show the menu (page 21).
- While in a menu, press to select an item or save an entry or setting (page 21).

### OFF/CANCEL

- During a call, press to hang up (page 31 or page 33).
- While the phone is ringing, press to silence the handset ringer temporarily (page 35).
- Press and hold to erase the missed call indicator when the phone is not in use (page 55).
- While in a menu, press to cancel an operation, back up to the previous menu, or exit the menu display (page 21).

### Dialing keys

- Press to enter numbers or characters.
- Press to answer an incoming call (page 30 or page 32).

### QUIET#

- Press and hold to set and turn on the quiet mode, or turn it off (page 29).
- Press repeatedly to show other dialing options when reviewing a caller ID log entry (page 56).

### MUTE/DELETE

- During a call, press to mute the microphone (page 35).
- While the phone is ringing, press to silence the handset ringer temporarily (page 35).
- While reviewing the redial list, directory or caller ID log, press to delete an individual entry (page 37, page 50 and page 57 respectively).
- While using the dialing keys, press to delete digits or characters.
- Press to delete the playing message or announcement (page 67 or page 60).

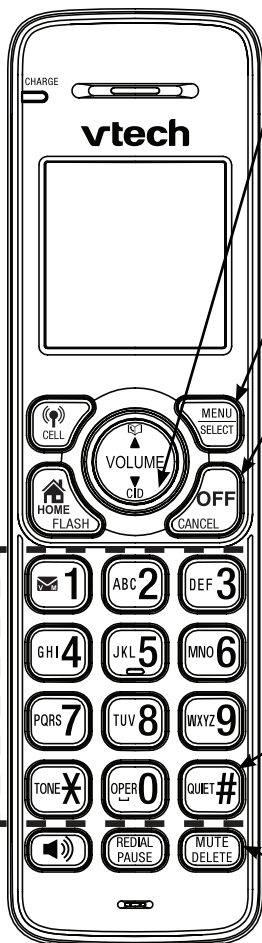

# Bluetooth

## Introducing Bluetooth

Your new **DS6641** telephone system with Bluetooth wireless technology has the following features:

- Pair and connect up to a maximum of two cell phones with the telephone base to make and receive cell calls. Only one cell phone can be active on a call at a time.
- Make and receive calls using your cell phone plan while utilizing the ease and comfort of your home telephone system.
- Receive phonebook entries from your cell phone.

## IMPORTANT INFORMATION

- Refer to the user's manual of your Bluetooth enabled cell phone for more information about how that device uses Bluetooth connectivity.
- Bluetooth wireless technology operates within a short range (a maximum of approximately 30 feet) from the telephone base. Keep connected cell phones within this range. For optimal performance, keep your cell phone within 15 feet of the telephone base while using the **DS6641** cell line.
- If your cell phone has poor reception in your home, the **DS6641** cannot improve the reception. However, if there is a location in your house with better reception, you can leave your cell phone at that location while you use the **DS6641** cell line.
- If you experience poor sound quality, your cell phone may be too far away from the telephone base. To improve Bluetooth signal strength, place your cell phone closer to the telephone base (within 15 feet) and make sure that there are no physical obstacles between the telephone base and the cell phone, such as large furniture or thick walls.

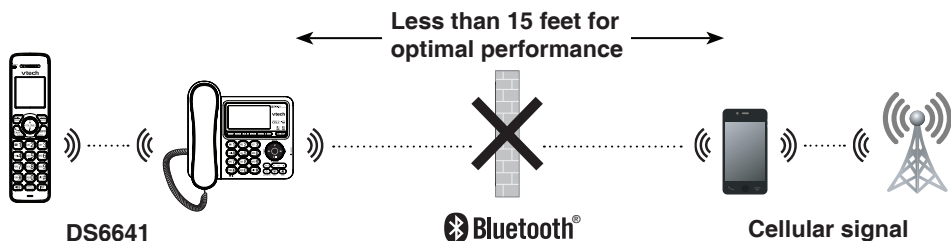

## Bluetooth

- Charge your cell phone while it is connected to the telephone base. Your cell phone's battery will discharge faster while it is connected to the telephone base via Bluetooth wireless technology.
- Monitor your cell phone's usage because minutes are deducted from your cellular plan for the duration of all cell calls, depending on the terms of your plan.

Refer to **Bluetooth setup** (page 17) to learn how to set up and manage your Bluetooth enabled devices. Refer to **Telephone operation** (page 30) on how to operate your Bluetooth devices with your new **DS6641** telephone system with Bluetooth wireless technology. Refer to **Troubleshooting** (page 78) if you experience difficulty using the telephone system.

The *Bluetooth*<sup>®</sup> word mark and logos are owned by Bluetooth SIG, Inc. and any use of such marks by VTech Holdings Limited is under license.

VTech Holdings Limited is a member of Bluetooth SIG, Inc. Other trademarks and trade names are those of their respective owners.



# Bluetooth



## Glossary of terms

Below are some terms used in this user's manual to help you become familiar with using your Bluetooth enabled cell phone and your new **DS6641** telephone system.

**Bluetooth cell phone** - refers to a Bluetooth enabled cellular telephone.

**Cell line** - the telephone line associated with your cell phone service. On your **DS6641** telephone base and handset, press /CELL to use the cell line.

**Connected** - when you pair a Bluetooth cell phone to the **DS6641**, it is automatically connected. When a cell phone is connected, **1** and/or **2** displays after  on the telephone and handset. The  **1** and/or  **2** light on the telephone base is on. If a cell phone loses its connection to the telephone base, it must be reconnected before you can use the cell phone with the **DS6641**.

**Disconnected** - when a cell phone is disconnected, the  on the telephone base and handset no longer displays. The  **1** /  **2** light on the telephone base is off.

**Discoverable mode** - before a Bluetooth enabled device can be paired, it must be set to this mode. When pairing your cell phone, the telephone base will be set to this mode. Depending on the manufacturer, this mode is sometimes referred to as **Find Me** or **Visibility**.

**Home line** - your conventional telephone land line. On your **DS6641** telephone base and handset, press /HOME to use the home line.

**Paired device** - once a Bluetooth enabled cell phone has been paired with the telephone base, it appears on the cell devices list. A maximum of two cell phones can be paired with the telephone base.

**Pairing** - this refers to the process of Bluetooth enabled cell phone registering device information with each other. The telephone base must be paired with a Bluetooth enabled cell phone before the Bluetooth cell phone can be used. Depending on the manufacturer, this is also referred to as **Bonding**.

**PIN** - by default, the PIN is **0000** for the telephone base and for most Bluetooth devices. PIN information may be exchanged between Bluetooth devices before they can be used. This is also known as a **Passkey** or **Passcode**.



# Bluetooth

## Bluetooth setup

To use a Bluetooth enabled cell phone with your **DS6641**, you must first pair and connect it with the telephone base. The **DS6641** telephone base and all system handsets can be used to make or answer calls on the cell phone line.

Bluetooth wireless technology operates within a short range (a maximum of approximately 30 feet). When you pair a Bluetooth cell phone to the telephone base, make sure your Bluetooth cell phone is close to the telephone base to maintain sufficient signal strength. For optimal performance, keep your cell phone within 15 feet of the telephone base while using the cell line.

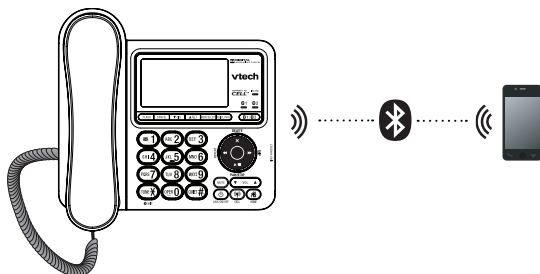

# Bluetooth

## Add a cell phone

Before you begin, make sure that you have cellular coverage and your Bluetooth enabled cell phone is not connected to any other Bluetooth devices. Refer to your cell phone user's manual to learn how to search for or add new Bluetooth devices.

You can pair and connect up to two cell phones to the telephone base. All paired cell phones are shown on the cell device list. Only one Bluetooth cell phone can be on a call at a time.

Once you have paired and connected a device with the telephone base, you do not need to repeat the procedure again unless you have replaced the paired cell phone with a new one.

### To pair and connect a cell phone:

1. Press **1/2** on the telephone base. You hear two beeps and the **1/2** light blinks.
  - When slot 1 is empty, the base screen displays **Pairing D1...** and the **1** light blinks.
  - When slot 1 is paired and slot 2 is empty, the base screen displays **Pairing D2...** and the **2** light blinks.
  - When both slots are paired, the base screen displays **Replace 1 or 2?** Use the dialing key to choose the desired slot. Then the corresponding light (**1** or **2**) blinks.
2. Turn on the Bluetooth feature of your cell phone. Once your cell phone finds your VTech phone (**VTech DS6641**), press the appropriate key on your cell phone to continue the pairing process.
  - Your cell phone may prompt you to enter the PIN of the telephone base. The default PIN of the telephone base is **0000**.
  - All cell phones that are connected to the telephone base are disconnected temporarily until the pairing process is completed.
3. When the cell phone is successfully paired and connected to the telephone base, you hear two beeps. The corresponding status icon (**1/2**) displays. The corresponding device light (**1/2**) turns on.

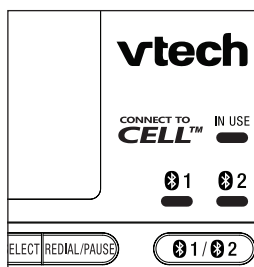

**If you have trouble pairing your cell phone, it may not be compatible with your DS6641. Check the Bluetooth compatibility list at [www.vtechphones.com](http://www.vtechphones.com).**

- note**
- The pairing process may take up to one minute. If the pairing process fails, try again.
  - The steps for the pairing process may vary for different cell phones. If this happens, follow the prompts on your cell phone and your **DS6641** to complete the pairing process.

# Bluetooth

## Review the cell devices list

1. Press **MENU** on the phone when it is not in use.
2. Press ▼ or ▲ to scroll to ♦**Bluetooth**, then press **SELECT**.
3. Press ▼ or ▲ to scroll to ♦**Cell devices**, then press **SELECT**.

## Auto connection

A cell phone may be disconnected from the telephone base when:

- The Bluetooth feature of your connected cell phone is turned off.
- The power of your cell phone is turned off.
- Your cell phone is not within range of the telephone base.

When the Bluetooth feature or power on the cell phone is turned on, or it moves within range of the base, the base will try to reconnect to the cell phone.

# Bluetooth

## Download directory

You can download up to 200 directories (phonebooks) to your **DS6641** telephone system via Bluetooth wireless technology. Each downloaded directory is stored in the phone directory with up to 24 digits for each phone number and 15 characters for each name.

Before downloading the directory, make sure the cell phone is paired and connected to the **DS6641**. Make sure the handset battery is charged for at least 10 minutes.

**Place your cell phone next to the telephone base while downloading.**

### To download a cell phone directory:

1. Press **MENU** when the handset/telephone base is not in use.
2. Press **▼** or **▲** to scroll to **Bluetooth**, then press **SELECT**.
3. Press **▼** or **▲** to scroll to **Download dir**, then press **SELECT**.

The screen displays **Select a device** briefly.

- If there is no cell phone paired to the system, the handset displays **Pair cell first** and then returns to the previous menu.
  - If there is no cell phone connected to the system, the handset displays **D1: not available/D2: not available**.
4. Press **▼** or **▲** to scroll to a desired device, then press **SELECT**.
    - If the selected device is not available, the handset displays **DX not avail.** and then returns to the previous menu.

During the download, the handset flashes **Downloading...**

All other idle system handsets display **Downloading...**

5. When the downloading process is complete or when the memory is full, the handset displays **Entries added: XXX**. Then the handset returns to the Bluetooth menu.

#### note

- Certain cell phones do not support SIM card download. If this is the case, try transferring the contacts from your SIM card to your cell phone memory first, then download from your cell phone memory. For more information on how to transfer contacts from your SIM card to your cell phone memory, see the user's manual of your cell phone.
- When downloading the directory from your Bluetooth enabled cell phone, some data may not transfer. For example, if you have home, mobile and work numbers for a particular contact, the three categories may not transfer to your **DS6641**.
- For certain cell phones, you may need to press a key on your cell phone to confirm the directory download.
- For Android and Blackberry cell phones, you may also download your cell phone directory to your **DS6641** via the VTech Contact Share application. Go to [www.vtechphones.com/apps/contact\\_share](http://www.vtechphones.com/apps/contact_share) for application download.

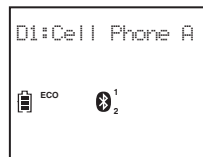

# Telephone settings

## Using the menu

You can use the telephone base or a cordless handset to change your telephone settings.

In the ringers menu, you can select the ringer tones and adjust the ringer volume for incoming calls.

In the settings menu, you can change the settings for LCD language, voicemail number, voicemail indicators, key tone, home area code and dial mode.

Go to **Answering system settings** from page 59 to page 63 for instructions on how to modify the answering system settings.

### To enter the menu:

1. Press **MENU** when the phone is not in use.
  2. Press ▼ or ▲ until the screen displays the desired feature menu.
  3. Press **SELECT** to enter that menu.
- To return to the previous menu, press **CANCEL**.
  - To return to idle mode, press and hold **CANCEL**.

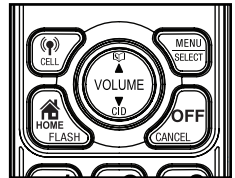
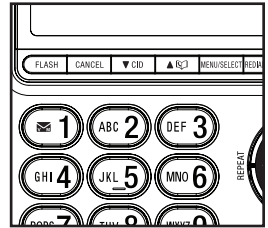

# Telephone settings

## Handset ringer volume

You can set the handset ringer volume or turn the ringer off. When the ringer is off, **Ringer off** and  appear on the screen.

1. Press **MENU** when the handset is not in use.
2. Press **▼** or **▲** to scroll to **↕Ringers**, then press **SELECT**.
3. Press **▼** or **▲** to scroll to **↕Home volume** or **↕Cell volume**, then press **SELECT**.
4. Press **▼** or **▲** to sample each volume level.
5. Press **SELECT** to save your selection and return to the previous menu. You hear a confirmation tone.

**note**

If the ringer volume is set to off, that device is silenced for all incoming calls. However, the handset still rings when being paged.

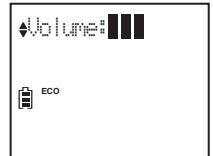
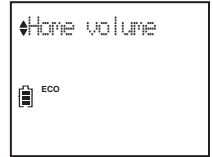
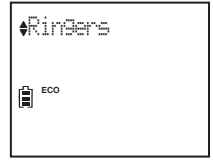

## Telephone base ringer volume

You can set the base ringer volume or turn the ringer off. When the ringer is off, **Ringer off** and  appear on the screen.

1. Press **MENU** when the telephone base is not in use.
2. Press **▼** or **▲** to scroll to **↕Ringers**, then press **SELECT**.
3. Press **▼** or **▲** to scroll to **↕Ringer volume**, then press **SELECT**.
4. Press **▼** or **▲** to sample each volume level.
5. Press **SELECT** to save your selection and return to the previous menu. You hear a confirmation tone.

**-OR-**

- Press **▼ VOL** or **VOL ▲** when the telephone base is not in use.

When you set the ringer volume to zero, the base ringer is off. The telephone base announces, "*Base ringer is off,*" and displays **Ringer off** and .

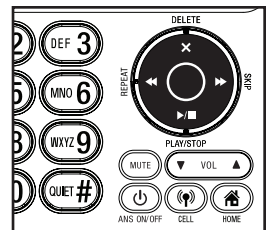

# Telephone settings

## Ringer tone

You can choose from different ringer tones for each handset and the telephone base.

1. Press **MENU** when the handset/telephone base is not in use.
2. Press **▼** or **▲** to scroll to **↕Ringers**, then press **SELECT**.
3. Press **▼** or **▲** to scroll to **↕Home ringtone** or **↕Cell ringtone**, then press **SELECT**.
4. Press **▼** or **▲** to sample each ringer tone.
5. Press **SELECT** to save your selection and return to the previous menu. You hear a confirmation tone.

**note**

If you turn off the ringer volume on a cordless handset, you will not hear ringer tone samples.

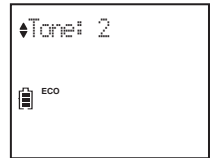
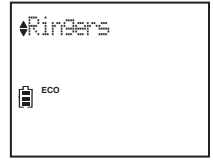

# Telephone settings

## Set date and time

The answering system announces the date and time of each message prior to playing it. Before using the answering system, set the date and time as follows. If you subscribe to caller ID service, the day, month and time are set automatically with each incoming call. However, the year must be correct so that the day of the week can be calculated from the caller ID information.

### To manually set the date and time:

1. Press **MENU** when the handset/telephone base is not in use.
2. Press **▼** or **▲** to scroll to **↕Set date/time**, then press **SELECT**.
3. Press **▼** or **▲** to select the month then press **SELECT**, or use the dialing keys to enter a two-digit number (**01-12**).
4. Press **▼** or **▲** to select the date then press **SELECT**, or use the dialing keys to enter a two-digit number (**01-31**).
5. Press **▼** or **▲** to select the year then press **SELECT**, or use the dialing keys to enter a two-digit number (**00-99**) then press **SELECT**.
6. Press **▼** or **▲** to select the hour then press **SELECT**, or use the dialing keys to enter a two-digit number (**01-12**).
7. Press **▼** or **▲** to select the minute then press **SELECT**, or use the dialing keys to enter a two-digit number (**00-59**).
8. Press **▼** or **▲** to select **AM** or **PM**.
9. Press **SELECT** to save the settings and return to the previous menu. You hear a confirmation tone.

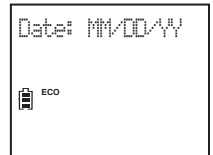

- note**
- If the date and time are not set when a message is recorded, the system announces, “*Time and date not set,*” before each message plays.
  - The telephone plays two beeps if you enter an invalid number.



# Telephone settings

## LCD language

You can select a language (**English**, **French** or **Spanish**) to be used in all screen displays.

1. Press **MENU** when the handset/telephone base is not in use.
2. Press **▼** or **▲** to scroll to **⬆Settings**, then press **SELECT**.
3. Press **SELECT** to select **⬆LCD language**.
4. Press **▼** or **▲** to select **⬆English**, **⬆Français** or **⬆Español**, then press **SELECT**.
  - The screen displays **Set English?** when you choose **English**.
  - The screen displays **Set Francais?** when you choose **Français**.
  - The screen displays **Set Espanol?** when you choose **Español**.
5. Press **SELECT** to save your selection and return to the previous menu. You hear a confirmation tone.

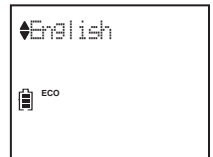



### note

If you accidentally change the LCD language to French or Spanish, you can reset it to English easily by pressing **MENU** then entering **\*364#**.

# Telephone settings

## Voicemail number

If you subscribe to voicemail service offered by your telephone service provider, you can save the voicemail number to  **1** on each handset and the telephone base for easy access. When you want to retrieve voicemail messages, press and hold  **1**. Contact your telephone service provider for more information and assistance about using your voicemail service.

### To save and dial your voicemail number:

1. Press and hold  **1** when the phone is not in use.
2. Use the dialing keys to enter the voicemail access number provided by your telephone service provider (up to 30 digits) when prompted.
  - Press **▼** or **▲** to move the cursor to the left or right.
  - Press **DELETE** on the handset or **X/DELETE** on the telephone base to delete a digit.
  - Press and hold **DELETE** on the handset or **X/DELETE** on the telephone base to delete all digits.
  - Press and hold **PAUSE** to enter a dialing pause (a **P** appears).
3. Press **SELECT** to save. Then the handset/telephone base dials the saved voicemail number.

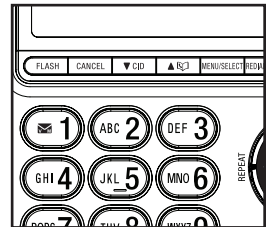
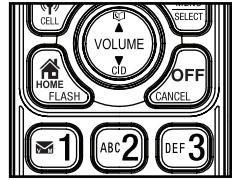

### To save your voicemail number:

1. Press **MENU** when the handset/telephone base is not in use.
2. Press **▼** or **▲** to scroll to **Settings**, then press **SELECT**.
3. Press **▼** or **▲** to scroll to **Voicemail #**, then press **SELECT**.
4. Use the dialing keys to enter the voicemail number (up to 30 digits).
  - Press **▼** or **▲** to move the cursor to the left or right.
  - Press **DELETE** on the handset or **X/DELETE** on the telephone base to delete a digit.
  - Press and hold **DELETE** on the handset or **X/DELETE** on the telephone base to delete all digits.
  - Press and hold **PAUSE** to enter a dialing pause (a **P** appears).
5. Press **SELECT** to save your selection and return to the previous menu. You hear a confirmation tone and the screen displays **VM # saved**.

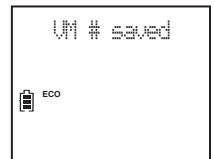
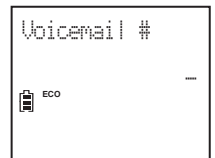
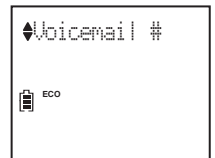

# Telephone settings

## Clear voicemail indicators

If you subscribe to voicemail service offered by your telephone service provider, **New voicemail** and  appear on the handset and the telephone base when you have new voicemail messages. Contact your telephone service provider for more information and assistance about using your voicemail service.

After you have listened to all new voicemail messages, the indicators on the handset and the telephone base turn off automatically.

Use the clear voicemail feature when the telephone indicates that there is new voicemail but there are none (for example, when you have accessed your voicemail while away from home). Clearing the voicemail waiting indicator only turns off the indicators; it does not delete your voicemail messages. As long as you have new voicemail messages, your telephone service provider continues to send the signal to turn on the indicators.

### To manually turn off the new voicemail indicators:

1. Press **MENU** when the handset/telephone base is not in use.
2. Press **▼** or **▲** to scroll to **◆Settings**, then press **SELECT**.
3. Press **▼** or **▲** to scroll to **◆Clr voicemail**, then press **SELECT**. The screen displays **Reset VM Icon?**
4. Press **SELECT** to save your selection and return to the previous menu. You hear a confirmation tone.

#### note

Your telephone service provider may alert you of new messages with a stutter (broken) dial tone. Contact your telephone service provider for details.

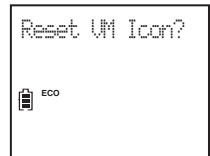
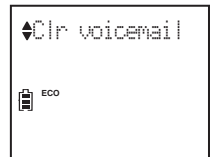

## Key tone

You can turn the key tone on or off for each handset and the telephone base.

If you turn the key tone on, the handset/telephone base beeps with each key press. If you turn the key tone off, there are no beeps when you press the handset/telephone base keys.

1. Press **MENU** when the handset/telephone base is not in use.
2. Press **▼** or **▲** to scroll to **◆Settings**, then press **SELECT**.
3. Press **▼** or **▲** to scroll to **◆Key tone**, then press **SELECT**.
4. Press **▼** or **▲** to select **◆Key tone:On** or **◆Key tone:Off**.
5. Press **SELECT** to save your selection and return to the previous menu. You hear a confirmation tone.

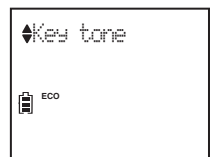

# Telephone settings

## Home area code

If you dial your local calls using only seven digits (area code not required), you can program your home area code so that when you receive a call within your local area, the telephone number is automatically stored without the area code in the caller ID log.

1. Press **MENU** when the handset/telephone base is not in use.
2. Press **▼** or **▲** to scroll to **⚡Settings**, then press **SELECT**.
3. Press **▼** or **▲** to scroll to **⚡Home area code**, then press **SELECT**.
4. Use the dialing keys to enter a three-digit home area code.
  - Press **DELETE** on the handset or **X/DELETE** on the telephone base to delete a digit.
  - Press and hold **DELETE** on the handset or **X/DELETE** on the telephone base to delete all digits.
5. Press **SELECT** to save your selection and return to the previous menu. You hear a confirmation tone.



**note** If, in the future, your telephone service provider requires you to dial the area code when making a local call, or, if you move to a location that requires it, follow the steps above to delete the home area code you have already programmed. After you have deleted the home area code, **\_ \_ \_** will appear on the screen.

## Dial mode

The dial mode is preset to touch-tone dialing. If you have pulse (rotary) service, you must change the dial mode to pulse dialing before using the telephone to make a call.

1. Press **MENU** when the handset/telephone base is not in use.
2. Press **▼** or **▲** to scroll to **⚡Settings**, then press **SELECT**.
3. Press **▼** or **▲** to scroll to **⚡Dial mode**, then press **SELECT**.
4. Press **▼** or **▲** to select **⚡Touch-tone** or **⚡Pulse**.
5. Press **SELECT** to save your selection and return to the previous menu. You hear a confirmation tone.

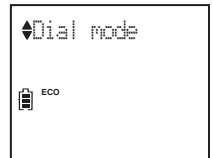



# Telephone settings

## Quiet mode

You can turn on quiet mode for a period of time (1-12 hours). During this period, all tones (except paging tone) and call screening are muted.

When you turn on the quiet mode, the answering system turns on automatically. When the quiet mode duration expires, the answering system remains on.

### To set and turn the quiet mode on:

1. Press and hold QUIET# when the handset/telephone base is not in use. The screen shows **Quiet: \_\_ hours (1-12)**.
2. Use the dialing keys to enter the desired duration (1-12), then press **SELECT**. All screens display **Quiet mode on** and . The  light on the telephone base turns on.



### To turn the quiet mode off:

- While the quiet mode is on, press and hold QUIET#. The screen displays **Quiet mode off** briefly and then returns to idle.



**note**

When you change the settings of the ringer tone or ringer volume, you can still hear the samples even if the quiet mode is on.

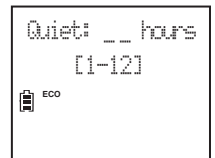

# Telephone operation

## Make a home call

### To make a home call on a cordless handset:

1. Press /HOME or .
2. When you hear a dial tone, dial the number.

### To make a home call at the telephone base:

1. Lift the corded handset, or press /HOME.
2. When you hear a dial tone, dial the number.

#### note

- The screen displays the elapsed time as you talk (in hours, minutes and seconds).
- While entering numbers, press and hold PAUSE to insert a dialing pause (a **P** appears).

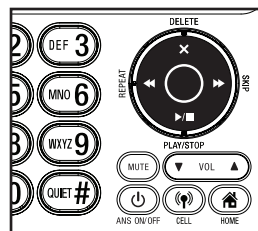
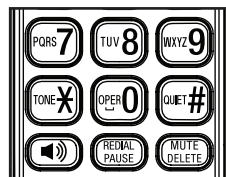
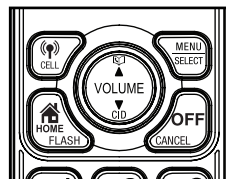

## Predial a home call

### To predial a home call on a cordless handset:

1. Enter the telephone number.
  - Press **DELETE** or **CANCEL** to make corrections.
2. Press /HOME or to dial.

### To predial a home call at the telephone base:

1. Enter the telephone number.
  - Press **X/DELETE** to make corrections.
2. Lift the corded handset, or press /HOME to dial.

#### note

- The screen displays the elapsed time as you talk (in hours, minutes and seconds).
- While entering numbers, press and hold PAUSE to insert a dialing pause (a **P** appears).
- If you make a predial call while the telephone line is in use, the screen displays **Unable to call** or **Line in use**.

## Answer a home call

### To answer a home call on a cordless handset:

- Press /HOME, /CELL, or any dialing key (0-9, **TONE X** or **QUIET #**).

### To answer a home call at the telephone base:

- Lift the corded handset, or press /HOME, /CELL or any dialing key (0-9, **TONE X** or **QUIET #**).

# Telephone operation

## End a home call

### To end a home call on a cordless handset:

- Press **OFF** or place the cordless handset in the handset charger.

### To end a home call at the telephone base:

- When you are using the corded handset, place it to the telephone base.
- When you are using the base speakerphone, press **🏠/HOME**.

## Call waiting on the home line

When you subscribe to call waiting service from your telephone service provider, you hear a beep if someone calls while you are already on a call.

- Press **FLASH** to put your current call on hold and take the new call.
- Press **FLASH** at any time to switch back and forth between calls.

## Make a cell call

### To make a cell call on a cordless handset:

1. Press **📶/CELL**. The handset displays **Select a device**.
  - If you have only one cell phone connected to the telephone base, press **SELECT** and then the handset displays **D1 selected**.
  - If you have two cell phones connected to the telephone base, press **▼** or **▲** to select a cell phone and then press **SELECT**. Then the handset displays **D1/D2 selected**.
2. Enter the telephone number, then press **📶/CELL** to dial.

### To make a cell call at the telephone base:

1. Press **📶/CELL** on the telephone base. The screen displays **Select a device**.
  - If you have only one cell phone connected to the telephone base, press **SELECT**, the screen displays **D1 selected**.
  - If you have two cell phone, press **▼** or **▲** to select a cell phone and then press **SELECT**, the screen displays **D1/D2 selected**.
2. Enter the telephone number, then press **📶/CELL** to dial.

- note**
- The screen shows the elapsed time as you talk (in hours, minutes and seconds).
  - While entering numbers, press and hold **PAUSE** to insert a dialing pause (a **P** appears).
  - While using the cell line, place your cell phone closer to the telephone base, and make sure that there are no physical obstacles such as large furniture or thick walls between the telephone base and the cell phone.

# Telephone operation

## Predial a cell call

### To predial a cell call on a cordless handset:

1. Enter the telephone number.
  - Press **DELETE** or **CANCEL** to make corrections.
2. Press **(P)/CELL** to dial.
  - If you have only one cell phone connected to the telephone base, it is automatically selected to make cell calls.
  - If you have two cell phones connected to the telephone base, the handset displays **Select a device**. Press **▼** or **▲** to select a cell phone and then press **SELECT**.
  - The handset displays **Unable to call** if your cell phone is in use.

### To predial a cell call at the telephone base:

1. Enter the telephone number.
  - Press **X/DELETE** to make corrections.
2. Press **(P)/CELL** to dial.
  - If you have only one cell phone connected to the telephone base, it is automatically selected to make cell calls.
  - If you have two cell phones connected to the telephone base, the telephone base displays **Select a device**. Press **▼** or **▲** to select a cell phone and then press **SELECT**.
  - The telephone base displays **Unable to call** if your cell phone is in use.

- note**
- The screen displays the elapsed time as you talk (in hours, minutes and seconds).
  - While entering numbers, press and hold **PAUSE** to insert a dialing pause (a **P** appears).

## Answer a cell call

### To answer a cell call on a cordless handset:

- Press **Ⓜ/HOME**, **(P)/CELL**, **(M)** or any dialing key (**0-9**, **TONEX** or **QUIET#**).

### To answer a cell call at the telephone base:

- Lift the corded handset, or press **Ⓜ/HOME**, **(P)/CELL** or any dialing key (**0-9**, **TONEX** or **QUIET#**).

- note**
- You can also use your cell phone to answer the call. If you answer with your cell phone, it will disconnect from the telephone base.



# Telephone operation

## End a cell call

### To end a cell call on a cordless handset:



Press **OFF** or place the cordless handset in the handset charger.

### To end a cell call at the telephone base:

- When you are using the corded handset, place it on the telephone base.
- When you are using the base speakerphone, press /CELL.

## Call waiting on the cell line

When you subscribe to call waiting service from your cell phone service provider, you hear a beep if someone calls while you are already on a call.

- Press /CELL on the cordless handset or **FLASH** on the telephone base to put your current call on hold and take the new call.
- Press /CELL on the cordless handset or **FLASH** on the telephone base at any time to switch back and forth between calls.

## Answer a cell call while on a home call

When you are on a home call and you receive an incoming cell call, you hear a beep, and  appears. All other system devices ring.

### To answer the incoming cell call:

Press /CELL on the cordless handset or the telephone base. The home line is still on hold.

### To resume the home call on hold:

Press /HOME on the cordless handset or the telephone base.

## Cell phone voicemail

If you have voicemail service active on your cell phone, and you do not answer the incoming cell call, the call will be answered by your cell phone's voicemail. Contact your cell phone service provider for more information about voicemail service.

# Telephone operation

## Answer a home call while on a cell call

When you are on a cell call and you receive an incoming home call, you hear a beep, and  appears. All other system devices ring.

### To answer the incoming home call:

Press /HOME on the cordless handset or the telephone base. The cell line is still on hold.

### To resume the cell call on hold:

Press /CELL on the cordless handset or the telephone base.





## Speakerphone

### Handset speakerphone:

When the cordless handset is on a call, press  to switch between the handset speakerphone and the handset earpiece.

When the speakerphone is active, the handset displays **Speaker** and the  light turns on.

### Telephone base speakerphone:

- When you are using the corded handset on a home line call, press /HOME to switch to the telephone base speakerphone.
- When you are using the corded handset on a cell line call, press /CELL to switch to the telephone base speakerphone.
- When you are using the telephone base speakerphone on a cell/home line, lift up the corded handset to use it.
- When the speakerphone is active, the telephone base displays **Speaker** and the /HOME or /CELL light turns on.

## Volume control

### To adjust the listening volume on a cordless handset:

During a call, press /VOLUME or /VOLUME.

### To adjust the listening volume at the telephone base:

During a call, press  VOL or VOL .

#### note

- The handset earpiece volume and speakerphone volume settings are independent.
- When the volume reaches the minimum or maximum setting, you hear two beeps.

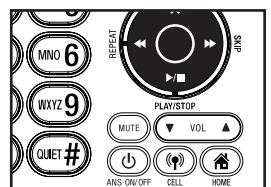
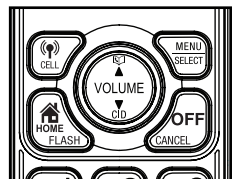

# Telephone operation

## Mute

The mute function allows you to hear the other party but the other party cannot hear you.

### To mute a call on a cordless handset:

- During a call, press **MUTE**. The handset displays **Muted** until the mute function is turned off.
- Press **MUTE** again to resume the conversation. The handset displays **Microphone on** briefly.



### To mute a call at the telephone base:

- During a call, press **MUTE**. The telephone base displays **Muted** and the **MUTE** light turns on until the mute function is turned off.
- Press **MUTE** again to resume the conversation. The telephone base displays **Microphone on** briefly.

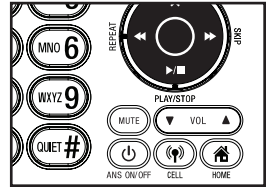

## Temporary ringer silencing

When the telephone is ringing, you can temporarily silence the handset ringer/telephone base ringer without disconnecting the call. The next call rings normally at the preset volume.

### To silence the handset ringer:

- Press **MUTE** or **OFF** on the handset.  displays and **Ringer muted** displays briefly.

### To silence the telephone base ringer:

- Press **MUTE** or **CANCEL** on the telephone base.  displays and **Ringer muted** displays briefly.

#### note

Each handset and the base ring when there is an incoming call unless the ringer volume is turned off on that device.

# Telephone operation

## Redial

The last 10 telephone numbers dialed (up to 30 digits) are stored in the system memory. Each handset and the telephone base store the last 10 telephone numbers dialed (up to 30 digits) independently. When there are already 10 entries, the oldest entry is deleted to make room for the new entry.

### To review and dial a redial number on a cordless handset:

1. Press **REDIAL** when the phone is not in use.
2. Press **▼**, **▲** or **REDIAL** repeatedly to browse for the desired entry.
3. Press **🏠/HOME** or **📶** to use the home line.

**-OR-**

Press **📶/CELL** to use the cell line. Press **▼** or **▲** to scroll to select the desired cell phone when necessary, then press **SELECT**.

**-OR-**

1. Press **🏠/HOME** or **📶** to use the home line.

**-OR-**

Press **📶/CELL** to use the cell line. Press **▼** or **▲** to scroll to select the desired cell phone when necessary, then press **SELECT**.

2. Press **REDIAL**.
3. Press **▼**, **▲** or **REDIAL** repeatedly to browse.
4. When the desired entry displays, press **SELECT** to dial.

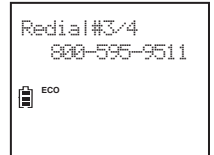

# Telephone operation

## To review and dial a redial number at the telephone base:

1. Press **REDIAL** when the phone is not in use.
2. Press **▼**, **▲** or **REDIAL** repeatedly to browse until the desired entry displays.
3. Press **🏠/HOME** or lift the corded handset to use the home line.

**-OR-**

Press **📶/CELL** to use the cell line. Press **▼** or **▲** to scroll to select the desired cell phone when necessary, then press **SELECT**.

**-OR-**

1. Press **🏠/HOME** or lift the corded handset to use the home line.

**-OR-**

Press **📶/CELL** to use the cell line. Press **▼** or **▲** to scroll to select the desired cell phone when necessary, then press **SELECT**.

2. Press **REDIAL**.

3. Press **▼**, **▲** or **REDIAL** repeatedly to browse.

4. When the desired entry displays, press **SELECT** to dial.

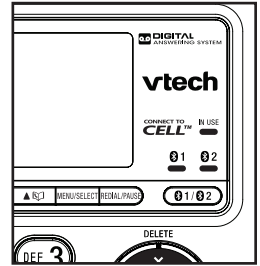

## To delete a redial number on a cordless handset:

- While the screen displays the desired number, press **DELETE** to delete the redial number.

## To delete a redial number at the telephone base:

- While the screen displays the desired number, press **X/DELETE** to delete the redial number.

## Temporary tone dialing

If you have pulse (rotary) service only, you can switch from pulse to touch-tone dialing temporarily during a call. This is useful if you need to send touch-tone signals to access your telephone banking or long distance services.

1. During a call, press **TONEX**.

2. Use the dialing keys to enter the number you wish to dial. The telephone sends touch-tone signals. It automatically returns to pulse dialing mode after you end the call.

# Telephone operation

## Check voicemail

- Press and hold  **1** to dial your voicemail number.



### note

To set your voicemail number, see **Voicemail number** on page 26.

## Chain dialing

Use this feature on the cordless handsets to initiate a dialing sequence from numbers stored in the directory, caller ID log or redial list while you are on a call.

Chain dialing can be useful if you wish to access other numbers (such as bank account numbers or access codes) from the directory, caller ID log or redial list.

### To access a number while on a call using the cordless handset:

1. To enter the directory, press **MENU/SELECT** twice.  
-OR-  
To enter the caller ID log, press **MENU**, then press ▼ or ▲ to scroll to **Caller ID log**, and then press **SELECT**.  
-OR-  
To enter the redial list, press **REDIAL**.
2. Press ▼ or ▲ to scroll to the desired entry.
3. Press **SELECT** to dial the displayed number.

### note

Press **CANCEL** to exit the directory, caller ID log or redial list while on a call.

### To access a number while on a call using the telephone base:

1. To enter the directory, press .  
-OR-  
To enter the caller ID log, press **CID**.  
-OR-  
To enter the redial list, press **REDIAL**.
2. Press ▼ or ▲ to scroll to the desired entry.
3. Press **SELECT** to dial the displayed number.

### note

Press **CANCEL** to exit the directory, caller ID log or redial list while on a call.

# Telephone operation

## Transfer a call

While on an outside call, you can transfer the call from one system device to another.

### To transfer a call on a cordless handset:

1. During a call, press **MENU**.
2. Press **▼** or **▲** to scroll to **Transfer**, then press **SELECT**.
  - When you have more than one handset, your handset shows **Transfer to:** Press **7** for the telephone base or **1-5** for **HANDSET 1** to **HANDSET 5**.

The outside call is put on hold and your handset shows **Transferring**, and then **Transferred**. The destination device rings and shows **Incoming call**.

3. To answer the call on the destination handset, press **HOME**, **CELL**, or any dialing key (**0-9**, **TONEX** or **QUIET#**).

**-OR-**

To answer the call on the telephone base, lift the corded handset, or press **HOME**, **CELL** or any dialing key (**0-9**, **TONEX** or **QUIET#**).



### To transfer a call at the telephone base:

1. During a call, press **MENU**.
  - When you have one handset, the screen displays **Transfer call?** Press **SELECT**.
  - When you have more than one handset, the telephone base shows **Transfer to:** Press **1-5** for **HANDSET 1** to **HANDSET 5**.

The outside call is put on hold and your telephone base shows **Transferring**, and then **Transferred**. The destination handset rings and shows **Incoming call**.

2. To answer the call on the destination handset, press **HOME**, **CELL** or any dialing key (**0-9**, **TONEX** or **QUIET#**).

#### note

- If the destination device does not answer the call within 30 seconds, the call will be reverted to the originating device. If the originating device does not answer the reverted call within 30 seconds, the call ends.
- If the destination device is in the directory or caller ID log, or is out of range, the originating device displays **Unable to call** and then reconnects to the outside call.

# Telephone operation

## Find handset

This feature helps you find misplaced handsets.

### To start the paging tone:

- Press **FIND HANDSET** at the side of the telephone base, and its screen displays **\*\* Paging \*\***. All idle handsets ring and display **\*\* Paging \*\***.

### To stop the paging tone:

- Press **⬆️/HOME**, **📶/CELL**, **🔊**, **OFF** or any dialing key (**0-9**, **TONEX** or **QUIET#**) on the cordless handset.  
**-OR-**
- Place the cordless handset in the handset charger.  
**-OR-**
- Press **FIND HANDSET** at the side of the telephone base.

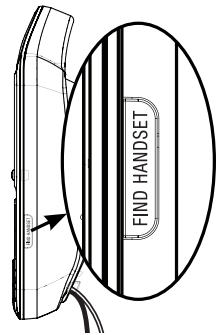

**note** Press **MUTE** to turn off the ringer of that handset temporarily. Paging tone continues on all other idle handsets.

## Web address

Use this feature to view the VTech website address.

1. Press **MENU** when the cordless handset/telephone base not in use.
2. Press **▼** or **▲** to scroll to **◆Web address**, then press **SELECT**.

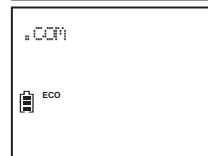
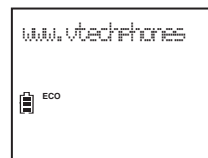
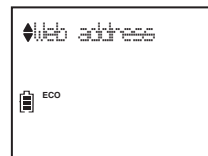





# Multiple handset use

## Join a call in progress



Another handset or the telephone base can join you on an outside call. That call continues until all parties hang up. You can use the telephone base and a cordless handset, or two cordless handsets at a time on an outside call.

You can buy additional expansion handsets (**DS6601**) for this telephone base. You can register up to five handsets to the telephone base.

### To join a call with a cordless handset:

- When a handset or the telephone base is already on a call, press /HOME or  on another handset to join the call.
- Press **OFF** or place the handset in the handset charger to exit the call. The call continues until both devices hang up.

### To join a call with the telephone base:

- Lift the corded handset or press /HOME.
- Place the corded handset back to the telephone base or press /HOME to exit the call. The call continues until both devices hang up.

# Multiple handset use

## Intercom

Use the intercom feature for conversations between the telephone base and a cordless handset, or two cordless handsets.

When you have two or more handsets, use the dialing keys to enter a device number to initiate an intercom call or to transfer a call.

- Press **7** for the telephone base or **1-5** for **HANDSET 1** to **HANDSET 5**.

### To initiate an intercom call with a cordless handset:

1. Press **MENU** on the cordless handset when not in use.
2. Press **▼** or **▲** to scroll to **Intercom**, then press **SELECT**.
  - If you have only one handset, the telephone base shows **Calling base**. The telephone base rings and shows **HS 1 is calling**.
  - If you have two or more handsets, your handset shows **Intercom to**. Use the dialing keys to enter a device number. Your handset shows **Calling HS X/Calling base**. The destination device rings and shows **HS X is calling**.

3. To answer the intercom call on the destination handset, press **HOME**, **CELL**, or any dialing key (**0-9**, **TONEX** or **QUIET#**). Both handsets now show **Intercom**.

**-OR-**

To answer the intercom call at the telephone base, press **HOME**, **CELL**, any dialing key (**0-9**, **TONEX** or **QUIET#**), or lift the corded handset. Both devices now show **Intercom**.

4. To end the intercom call on either handset, one party presses **OFF**, or places the handset back in the handset charger. Both handsets display **Intercom ended**.

**-OR-**

To end the intercom call at the telephone base, press **HOME** or **CELL** when using the base speakerphone, or place the corded handset back to the telephone base. Both screens display **Intercom ended**.

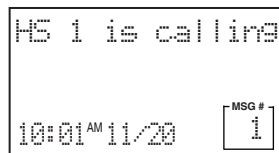
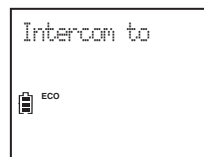
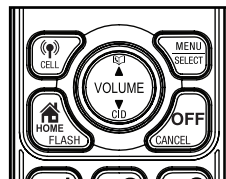

- note**
- You can cancel the intercom call before it is answered by pressing **CANCEL**.
  - If the destination handset is not powered, out of range, on a call, or does not answer the intercom call within 100 seconds, your handset displays **Unable to call** and then returns to idle mode.
  - If the telephone base is on a call, or does not answer the intercom call within 100 seconds, your handset displays **Unable to call** and then returns to idle mode.
  - You can press **OFF** or **MUTE** on the cordless handset, or **CANCEL** or **MUTE** on the telephone base to temporarily silence the intercom ringer.
  - Two intercom calls can be established at a time.

# Multiple handset use

## Intercom

### To initiate an intercom call at the telephone base:

1. Press **MENU** on the telephone base when not in use.
2. Press **▼** or **▲** to scroll to **Intercom**, then press **SELECT**.

- If you have only one handset, the telephone base shows **Calling HS 1**. The handset rings and shows **Base is calling**.
- If you have two or more handsets, the telephone base shows **Intercom to**. Use the dialing keys to enter a handset number. The telephone base shows **Calling HS X**. The destination handset rings and shows **Base is calling**.

3. To answer the intercom call on the destination handset, press **HOME**, **CELL**, or any dialing key (**0-9**, **TONEX** or **QUIET#**). Both devices now show **Intercom**.
4. To end the intercom call at the telephone base, press **HOME** or **CELL** when using the base speakerphone, or place the corded handset back to the telephone base. Both screens display **Intercom ended**.

**-OR-**

To end the intercom call on the destination handset, press **OFF**, or place the handset back in the handset charger. Both screens display **Intercom ended**.

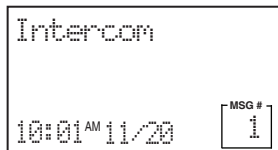
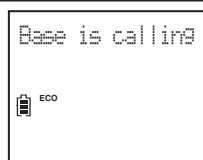
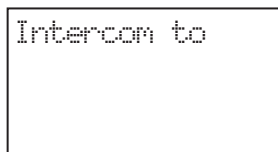
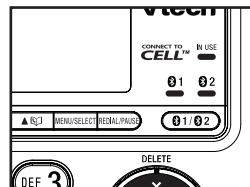



- note**
- You can cancel the intercom call before it is answered by pressing **CANCEL**.
  - If the destination handset is not powered, out of range, on a call, or does not answer the intercom call within 100 seconds, your telephone base displays **Unable to call** and then returns to idle mode.
  - You can press **OFF** or **MUTE** on the cordless handset to temporarily silence the intercom ringer.
  - Two intercom calls can be established at a time.

## Multiple handset use







### Answer an incoming call during an intercom call

If you receive an incoming outside call during an intercom call, you will hear an alert tone.

#### To answer on a cordless handset:

- To answer a home call, press /HOME. The intercom call ends automatically.
- To answer a cell call, press **OFF** to end the intercom call. The telephone continues to ring. Then press /CELL.
- To end the intercom call without answering the outside call, press **OFF**. The intercom call ends and the telephone continues to ring.

#### To answer at the telephone base:

- To answer a home call, press /HOME or place the corded handset back to the telephone base to end the intercom call. The telephone continues to ring. Then press /HOME.
- To answer a cell call, press /HOME or place the corded handset back to the telephone base to end the intercom call. The telephone continues to ring. Then press /CELL.
- To end the intercom call without answering the outside call, press /HOME or /CELL, or place the corded handset back to the telephone base. The intercom call ends and the telephone continues to ring.

# Directory

## About the directory

The directory stores up to 200 entries with up to 30 digits for each phone number and 15 characters for each name.

- Directory entries are shared by all handsets and the telephone base. Any modifications made on one device apply to all.
- When you access the directory without records, the screen shows **Directory empty**.
- When the directory is full and you try to save an entry, the screen shows **Directory full**.
- When you try to save an entry already stored in the directory, the screen shows **Number repeated**.
- When the telephone number in the directory exceeds 15 digits, a dash appears after the 14th digit, and the remaining digits are then displayed beginning with a dash.
- Only one system device can review the directory at a time. When a device tries to enter the directory while another device is already in it, **Not available** appears.

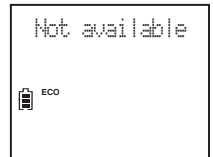
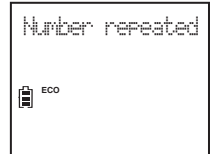

# Directory

## Add a directory entry

1. Press **MENU** on the cordless handset when the phone is not in use, or press **MENU** on the telephone base when the telephone base is not in use.
2. Press **▼** or **▲** to scroll to **◆Directory**, then press **SELECT**.
3. Press **▼** or **▲** to scroll to **◆Add contact**, then press **SELECT**.
4. When **Enter number** displays, use the dialing keys to enter a number (up to 30 digits).
  - Press **▼** or **▲** to move the cursor to the left or right.
  - Press **DELETE** on the handset or **X/DELETE** on the telephone base to delete a digit.
  - Press and hold DELETE on the handset or **X/DELETE** on the telephone base to delete all digits.
  - Press and hold PAUSE to enter a dialing pause (a **P** appears).

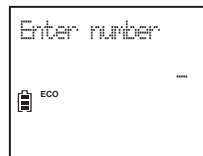
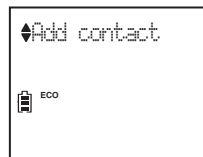

**-OR-**

Copy a number from the redial list by pressing **REDIAL**. Then press **▼**, **▲** or **REDIAL** repeatedly to find the desired number.  
Press **SELECT** to copy the number.

5. Press **SELECT** to move on to the name.
6. When **Enter name** displays, use the dialing keys to enter a name (up to 15 characters). Each time you press a key, the character on that key appears. Additional key presses produce other characters on that key. Press the key repeatedly until the desired character appears. The first character of each word is capitalized.
  - Press **▼** or **▲** to move the cursor to the left or right.
  - Press **0** to add a space.
  - Press **DELETE** on the handset or **X/DELETE** on the telephone base to delete a character.
  - Press and hold DELETE on the handset or **X/DELETE** on the telephone base to delete all characters.
7. Press **SELECT** to save. The screen displays **Saved** and you hear a confirmation tone.

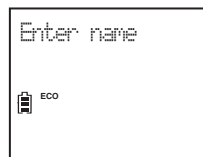

# Directory

## Add a directory entry

-OR-

1. Use the dialing keys to enter a number (up to 30 digits) on the cordless handset when the phone is not in use, or use the dialing keys to enter a number (up to 30 digits) on the telephone base when the telephone base is not in use. Press **SELECT** and then the screen displays **Enter number**.

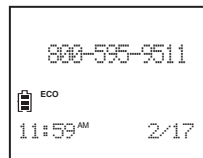

- Press ▼ or ▲ to move the cursor to the left or right.
- Press **DELETE** on the handset or **X/DELETE** on the telephone base to delete a digit.
- Press and hold **DELETE** on the handset or **X/DELETE** on the telephone base to delete all digits.
- Press and hold **PAUSE** to enter a dialing pause (a **P** appears).

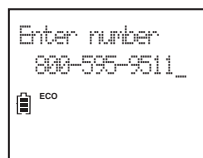

-OR-

Copy a number from the redial list by pressing **REDIAL**. Then press ▼, ▲ or **REDIAL** repeatedly to find the desired number. Press **SELECT** to copy the number.

2. Press **SELECT** to move on to the name.
3. When **Enter name** displays, use the dialing keys to enter a name (up to 15 characters). Each time you press a key, the character on that key appears. Additional key presses produce other characters on that key. Press the key repeatedly until the desired character appears. The first character of each word is capitalized.

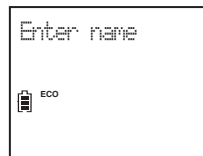





- Press ▼ or ▲ to move the cursor to the left or right.
  - Press **0** to add a space.
  - Press **DELETE** on the handset or **X/DELETE** on the telephone base to delete a character.
  - Press and hold **DELETE** on the handset or **X/DELETE** on the telephone base to delete all characters.
4. Press **SELECT** to save. The screen displays **Saved** and you hear a confirmation tone.







# Directory

## Review directory entries

Directory entries appear alphabetically.





1. Press  on the cordless handset when the phone is not in use, or  on the telephone base when the telephone base is not in use to show the first entry in the directory.
2. Press  or  to browse through the directory.

**-OR-**







1. Press **MENU** on the cordless handset when the phone is not in use, or press **MENU** on the telephone base when the telephone base is not in use.
2. Press  or  to scroll to **Directory**, press **SELECT**.
3. Press  or  to scroll to **Review**, then press **SELECT**.
4. Press  or  to browse through the directory.



## Alphabetical search

1. Press  on the cordless handset when the phone is not in use, or  on the telephone base when the telephone base is not in use to show the first entry in the directory.
2. Use the dialing keys to enter the letter associated with the name. For example, if you have the entries named Jennifer, Jessie, Kevin and Linda in your directory, press **5** (JKL) once to see **Jennifer** (when **Jennifer** displays, press  to see **Jessie**), twice to see **Kevin**, or three times to see **Linda**. If there is no name entry matching your search, the next closest match in alphabetical order appears. If necessary, press  or  to browse.

**-OR-**

1. Press **MENU** on the cordless handset when the phone is not in use, or press **MENU** on the telephone base when the telephone base is not in use.
2. Press  or  to scroll to **Directory**, press **SELECT**.
3. Press  or  to scroll to **Review**, then press **SELECT**.
4. Use the dialing keys to enter the letter associated with the name. For example, if you have the entries named Jennifer, Jessie, Kevin and Linda in your directory, press **5** (JKL) once to see **Jennifer** (when **Jennifer** displays, press  to see **Jessie**), twice to see **Kevin**, or three times to see **Linda**. If there is no name entry matching your search, the next closest match in alphabetical order appears. If necessary, press  or  to browse.



# Directory

## Dial a directory entry

1. Search for the desired entry in the directory (see **Review directory entries** or **Alphabetical search** on page 48).
2. To dial the displayed entry on the cordless handset, press **HOME**, **CELL** or **END**.

**-OR-**

To dial the displayed entry on the telephone base, press **HOME** or **CELL**, or lift the corded handset.

**-OR-**

1. Press **HOME**, **CELL** or **END** on the cordless handset.

**-OR-**

Lift the corded handset or press **HOME** or **CELL** on the telephone base.

2. Press **MENU**.
3. Press **SELECT** to select **Directory**.
4. Press **DOWN** or **UP** or start an alphabetical search to browse to the desired entry, then press **SELECT** to dial the displayed number.

## Edit a directory entry

1. Search for the desired entry in the directory (see **Review directory entries** or **Alphabetical search** on page 48).
2. When the desired entry displays, press **SELECT**. The screen displays **Edit number** and the stored number.
3. Use the dialing keys to edit the number.
  - Press **DOWN** or **UP** to move the cursor to the left or right.
  - Press **DELETE** on the handset or **X/DELETE** on the telephone base to delete a digit.
  - Press and hold DELETE on the handset or **X/DELETE** on the telephone base to delete all digits.
  - Press and hold PAUSE to enter a dialing pause (a **P** appears).
4. Press **SELECT**. The screen displays **Edit name** and then the stored name.
5. Use the dialing keys to edit the name.
  - Press **DOWN** or **UP** to move the cursor to the left or right.
  - Press **DELETE** on the handset or **X/DELETE** on the telephone base to delete a character.
  - Press and hold DELETE on the handset or **X/DELETE** on the telephone base to delete all characters.
  - Press **0** to add a space.
6. Press **SELECT** to save the entry. The screen displays **Saved** and then the revised entry. You hear a confirmation tone.



# Directory

## Delete directory entries

### To delete one entry:

1. Search for the desired entry in the directory (see **Review directory entries** or **Alphabetical search** on page 48).
2. Press **DELETE**. The screen displays **Delete contact?** with the telephone number.
3. Press **SELECT** to confirm. The screen displays **Contact deleted**. You hear a confirmation tone.

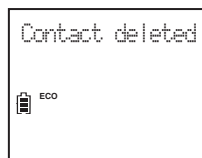

### To delete all entries:

1. Press **MENU** when the phone is not in use.
2. Press **▼** or **▲** to scroll to **◆Directory** and then press **SELECT**.
3. Press **▼** or **▲** to scroll to **◆Del all conts** then press **SELECT**. The screen displays **Delete all?**
4. Press **SELECT** to confirm. You hear a confirmation tone.



# Directory

## Speed dial

You can copy up to nine directory entries into the speed dial locations (**0** and **2-9**) so that you can dial these numbers via the home line more quickly.

The speed dial memory locations are stored at the telephone base and are shared by all system devices. Changes made to the speed dial entries on one system device apply to all.

## Assign a speed dial number

1. Press **MENU** when the phone is not in use.
2. Press ▼ or ▲ to scroll to ↗**Directory**, then press **SELECT**.
3. Press ▼ or ▲ to scroll to ↗**Speed dial**, then press **SELECT**.
4. Press ▼, ▲ or a dialing key (**0** or **2-9**) to choose the desired speed dial location.
5. Press **SELECT**. The screen displays **Copy from DIR...** and then the first entry in the directory.
6. Press ▼ or ▲ to scroll to desired entry.
7. Press **SELECT** to save your selection and return to the previous menu. You hear a confirmation tone.

**note**

If the directory is empty when you press **SELECT** in Step 5, the screen shows **Directory empty**.

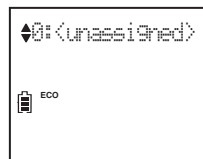

## Reassign a speed dial number

1. Press **MENU** when the phone is not in use.
2. Press ▼ or ▲ to scroll to ↗**Directory**, then press **SELECT**.
3. Press ▼ or ▲ to scroll to ↗**Speed dial**, then press **SELECT**.
4. Press ▼, ▲ or a dialing key (**0** or **2-9**) to choose the speed dial location you want to reassign.
5. Press **SELECT** twice. The screen displays ↗**Reassign SD**.
6. Press **SELECT**. The screen briefly shows **Copy from DIR...** then the first entry of the directory.
7. Press ▼ or ▲ to scroll to the desired entry.
8. Press **SELECT** to save your selection and return to the previous menu. You hear a confirmation tone.

# Directory

## Dial a speed dial number

When the phone is not in use, press and hold a dialing key (**0** or **2-9**) to dial the number stored in the corresponding speed dial location.

**-OR-**

1. Press **MENU** when the phone is not in use.
2. Press ▼ or ▲ to scroll to **↕Directory**, then press **SELECT**.
3. Press ▼ or ▲ to scroll to **↕Speed dial**, then press **SELECT**.
4. Press ▼, ▲ or a dialing key (**0** or **2-9**) to choose the desired speed dial location.
5. When you are using a cordless handset, press **🏠/HOME**, **📶/CELL** or **📞**).

**-OR-**

When you are using the telephone base, press **🏠/HOME** or **📶/CELL**, or lift the corded handset.

**note**

When the speed dial location is empty, the handset shows the speed dial list. See **Assign a speed dial number** on page 51 to add a new entry.

## Delete a speed dial number

1. Press **MENU** when the phone is not in use.
2. Press ▼ or ▲ to scroll to **↕Directory**, then press **SELECT**.
3. Press ▼ or ▲ to scroll to **↕Speed dial**, then press **SELECT**.
4. Press ▼, ▲ or a dialing key (**0** or **2-9**) to choose the desired speed dial location, then press **SELECT** to show the speed dial entry.
5. Press **SELECT** again. Then press ▼ or ▲ to scroll to **↕Clear SD** and then press **SELECT**. The screen shows **Clear SD #X?**

**-OR-**

Press **DELETE**. The screen shows **Clear SD #X?**

6. Press **SELECT** to confirm and return to the previous menu. You hear a confirmation tone.

**note**

Deleting the speed dial entries does not affect the entries in the directory.

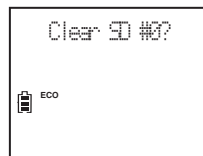
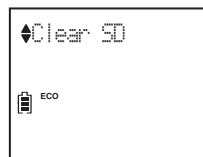

# Caller ID

## About the caller ID log

This product supports caller ID services offered by most telephone service providers. Depending on your service subscription, you may see the caller's number, or the caller's name and number that are sent by your telephone service provider after the first or second ring. Caller ID allows you to see the name, number, date and time of calls.

## Information about caller ID with call waiting

Caller ID with call waiting lets you see the name and telephone number of the caller before answering the call, even while on another call.

It may be necessary to change your telephone service to use this feature. Contact your telephone service provider if:

- You have both caller ID and call waiting, but as separate services (you may need to combine these services).
- You have only caller ID service, or only call waiting service.
- You do not subscribe to caller ID log or call waiting services.

There are fees for caller ID services. In addition, services may not be available in all areas.

This product can provide information only if both you and the caller are in areas offering caller ID service and if both telephone service providers use compatible equipment. The time and date, along with the call information, are from the telephone service provider.

Caller ID information may not be available for every incoming call. Callers may intentionally block their names and/or telephone numbers. To view caller ID log entries with numbers between 16 and 24 digits, you must save the entry to the directory (see page 57).

You can use this product with regular caller ID service, or you can use this product's other features without subscribing to caller ID or combined caller ID with call waiting service.

# Caller ID

## Caller ID log

If you subscribe to caller ID service, information about each caller will appear after the first or second ring. If you answer a call before the caller's information appear on the screen, it will not be saved in the caller ID log.

- The caller ID log stores up to 50 entries. Each entry has up to 24 digits for the phone number and 15 characters for the name. If the phone number has more than 15 digits, only the last 15 digits appear. If the name has more than 15 characters, only the first 15 characters are shown and saved in the caller ID log.
- Caller ID log entries are shared by all system devices. Any modifications made on one device apply to all.
- You can review, redial, and copy an entry into the directory.
- Entries appear in reverse chronological order.
- When the caller ID log is full, the oldest entry is deleted to make room for new incoming call information.
- **XX missed calls** shows when there are new caller ID log entries that have not been reviewed.
- **Call log empty** shows when you access the caller ID log without records.
- Only one system device can review the caller ID log at a time. If a system device tries to enter the caller ID log while another system device is already in it, its screen displays **Not available**.

# Caller ID

## Missed call indicator

When there are calls that have not been reviewed in the caller ID log, the screens display **XX missed calls**. When you have reviewed all the missed calls, the missed call indicator goes away.

Each time you review a caller ID log entry marked **NEW** on the handset or **NEW** on the telephone base, the number of missed calls decreases by one.

If you do not want to review the missed calls one by one, press and hold **CANCEL** when not in use to clear the missed call indicator. All the entries are then considered old and kept in the caller ID log.

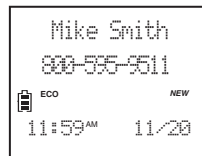
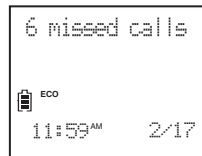

## Review the caller ID log

Review the caller ID log to find out who called, to return the call, or to copy the caller's name and number into your directory.

1. Press **CID** on the cordless handset when the phone is not in use, or press **CID** on the telephone base when the telephone base is not in use.

2. Press ▼ or ▲ to browse.

**-OR-**

1. Press **MENU** on the cordless handset when the phone is not in use, or press **MENU** on the telephone base when the telephone base is not in use.

2. Press ▼ or ▲ to scroll to **Caller ID log**, then press **SELECT**.

3. Press **SELECT** to select **Review**.

4. Press ▼ or ▲ to browse.

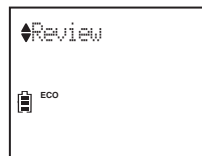
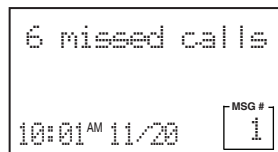

# Caller ID

## View dialing options

Although the caller ID log entries received have 10 digits (the area code plus the seven-digit number), in some areas, you may need to dial only the seven digits, or 1 plus the seven digits, or 1 plus the area code plus the seven digits. You can change the number of digits that you dial from the caller ID log and store the new number to the directory.

While reviewing the caller ID log, press **QUIET#** repeatedly to display different dialing options for local and long distance numbers before dialing or saving the telephone number in the directory.

Press **1** repeatedly if you need to add or remove 1 in front of the telephone number before dialing or saving it in the directory.

When the number is displayed in the correct format for dialing, press **HOME**, **CELL** or **END** on a cordless handset, or press **HOME** or **CELL**, or lift the corded handset on the telephone base to dial.

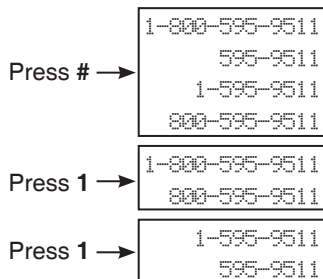

## Dial a caller ID log entry

### To dial on a cordless handset:

1. Search for the desired caller ID log entry (see **Review the caller ID log** on page 55).
2. When the desired entry displays, press **HOME**, **CELL** or **END** to dial.

### To dial at the telephone base:

1. Search for the desired caller ID log entry (see **Review the caller ID log** on page 55).
2. When the desired entry displays, press **HOME** or **CELL**, or lift the corded handset to dial.



# Caller ID

## Save a caller ID log entry to the directory

1. Search for the desired caller ID log entry (see **Review the caller ID log** on page 55).
2. When the desired entry displays, press **SELECT**. The screen displays **Edit number**.
3. Use the dialing keys to edit the number.
  - Press ▼ or ▲ to move the cursor to the left or right.
  - Press **DELETE** on the handset or **X/DELETE** on the telephone base to backspace and delete a digit.
  - Press and hold **DELETE** on the handset or **X/DELETE** on the telephone base to delete the entire entry.
  - Press and hold **PAUSE** to insert a dialing pause (a **P** appears).
4. Press **SELECT** to move to the name. The screen displays **Edit name**.
5. Use the dialing keys to add or edit the name.
  - Press ▼ or ▲ to move the cursor to the left and right.
  - Press **DELETE** on the handset or **X/DELETE** on the telephone base to delete a character.
  - Press and hold **DELETE** on the handset or **X/DELETE** on the telephone base to delete all characters.
  - Press **0** to add a space.
6. Press **SELECT** to save and the screen shows **Saved**. You hear a confirmation tone.

## Delete caller ID log entries

### To delete one entry:

1. Search for the desired caller ID log entry (see **Review the caller ID log** on page 55).
2. Press **DELETE** to delete the displayed entry. You hear a confirmation tone.



### To delete all entries:

1. Press **MENU** on the cordless handset when the phone is not in use, or press **MENU** on the telephone base when the telephone base is not in use.
2. Press ▼ or ▲ to scroll to **Caller ID log**, then press **SELECT**.
3. Press ▼ or ▲ to scroll to **Del all calls**, then press **SELECT**.
4. When the screen shows **Delete all?**, press **SELECT** to confirm. You hear a confirmation tone.



# Caller ID

## Caller ID log screen messages

Displays:	When:
PRIVATE NAME	The caller is blocking the name information.
PRIVATE NUMBER	The caller is blocking the telephone number information.
PRIVATE CALLER	The caller is blocking the name and number information.
UNKNOWN NAME	This caller's name is unavailable.
UNKNOWN NUMBER	This caller's number is unavailable.
UNKNOWN CALLER	No information is available about this caller.

# Answering system settings

## Answering system

Use the answering system menu of a cordless handset or telephone base to turn on or off the answering system or message alert tone, set up the announcement message, activate the call screening, or change the number of rings, remote access code or message recording time.



## Announcement

The telephone is preset with a greeting that answers calls with, *“Hello. Please leave a message after the tone.”* You can use this preset announcement, or replace it with your own.

## Record your own announcement

You can record an announcement up to 90 seconds, but any announcement shorter than two seconds will not be recorded.

1. Press **MENU** when the phone is not in use.
2. Press **▼** or **▲** to scroll to **◆Answering sys**, then press **SELECT**.
3. Press **SELECT** again to select **◆Announcement**. The system announces, *“To play, press 2. To record, press 7.”*
4. Press **7** to record an announcement. The system announces, *“Record after the tone. Press 5 when you are done.”*
5. After the tone, speak towards the microphone.
6. Press **5** when done. The answering system automatically plays back the newly recorded announcement, then returns to the previous menu.

**-OR-**

Press **CANCEL** to return to the previous menu.

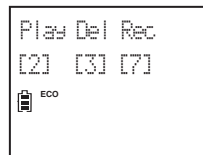
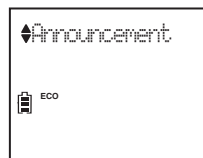

# Answering system settings

## Play your announcement

1. Press **MENU** when the phone is not in use.
2. Press **▼** or **▲** to scroll to **◆Answering sys**, then press **SELECT**.
3. Press **SELECT** again to select **◆Announcement**. The system announces, *“To play, press 2. To record, press 7.”*
4. Press **2** to play the current announcement.
  - Press **▼/VOLUME** or **▲/VOLUME** on the handset, or **▼ VOL** or **VOL ▲** on the telephone base to adjust the listening volume.
  - Press **5** to stop playback.
  - Press **⏸** on the cordless handset to switch between speakerphone mode and handset mode.

## Delete your announcement

1. Press **MENU** when the phone is not in use.
2. Press **▼** or **▲** to scroll to **◆Answering sys**, then press **SELECT**.
3. Press **SELECT** again to select **◆Announcement**. The system announces, *“To play, press 2. To record, press 7.”*
4. Press **3** or **DELETE** to delete your recorded announcement. The screen displays **Annc deleted**. You hear a long beep.

**note**

When your announcement is deleted, calls are answered with the preset announcement.

# Answering system settings

## Answer on/off

The answering system must be turned on to answer and record messages.

When the answering system is turned on, the **ANS ON/OFF** light on the telephone base turns on and **ANS ON** displays on the handset.

On the telephone base, press **ANS ON/OFF** to turn the answering system on or off. When the answering system is turned on, the base displays **Ans sys on** and announces, "Calls will be answered." When the answering system is turned off, the base displays **Ans sys off** and announces, "Calls will not be answered."

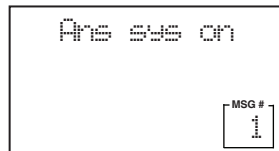
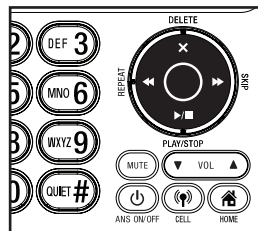

**-OR-**

1. Press **MENU** when the phone is not in use.
2. Press **▼** or **▲** to scroll to **Answering sys**, then press **SELECT**.
3. Press **▼** or **▲** to scroll to **Answer on/off**, then press **SELECT**.
4. Press **▼** or **▲** to scroll to **Answer: On** or **Answer: Off**, then press **SELECT** to confirm. You hear a confirmation tone.

**note**

- When you turn on the answering system with no memory capacity left, **Rec mem full** displays on the cordless handset and telephone base. The answering system announces, "Memory is full."
- If the memory capacity is less than 3 minutes, the telephone announces, "Less than three minutes to record."

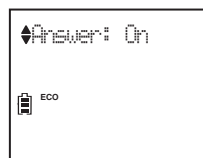
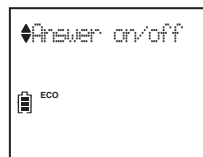

# Answering system settings

## Call screening

Use this feature to choose whether incoming messages can be heard when they are being recorded.

1. Press **MENU** when the phone is not in use.
2. Press ▼ or ▲ to scroll to **◆Answering sys**, then press **SELECT**.
3. Press ▼ or ▲ to scroll to **◆Ans sys setup**, then press **SELECT**.
4. Press **SELECT** to select **◆Call screening**.
5. Press ▼ or ▲ to select **◆Screening: On** or **◆Screening: Off**.
6. Press **SELECT** to save and you hear a confirmation tone.

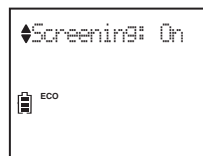
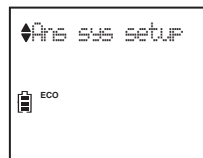

## Number of rings

You can choose two, three, four, five or six rings; or toll saver. With toll saver selected, the answering system answers after two rings if you have new messages, or after four rings when there are no new messages. This enables you to check for new messages and avoid paying long distance charges when calling from out of your local area.

1. Press **MENU** when the phone is not in use.
2. Press ▼ or ▲ to scroll to **◆Answering sys**, then press **SELECT**.
3. Press ▼ or ▲ to scroll to **◆Ans sys setup**, then press **SELECT**.
4. Press ▼ or ▲ to scroll to **◆# of rings**, then press **SELECT**.
5. Press ▼ or ▲ to select **◆2**, **◆3**, **◆4**, **◆5**, **◆6** or **◆Toll saver**.
6. Press **SELECT** to save and you hear a confirmation tone.

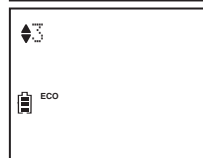
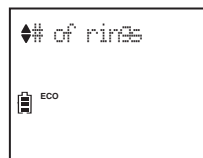

**note**

If you subscribe to voicemail service from your telephone service provider, see **Answering system and voicemail** on page 64.

## Remote access code

A two-digit security code is required to access the answering system remotely from any touch-tone telephone. The preset code is **19**. You can set the code from **00** to **99**.

1. Press **MENU** when the phone is not in use.
2. Press ▼ or ▲ to scroll to **◆Answering sys**, then press **SELECT**.
3. Press ▼ or ▲ to scroll to **◆Ans sys setup**, then press **SELECT**.
4. Press ▼ or ▲ to scroll to **◆Remote code**, then press **SELECT**.
5. Press ▼ or ▲, or use the dialing keys (**0-9**) to enter a two-digit number.
6. Press **SELECT** to save and you hear a confirmation tone.

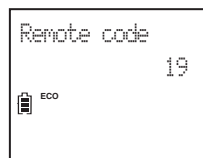
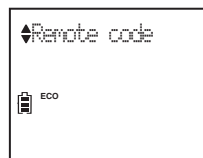

# Answering system settings

## Message alert tone

When the message alert tone is set to on, and there is at least one new message, the telephone base beeps every 10 seconds. The message alert tone is preset to off.

There is no audible alert at the handset.

1. Press **MENU** when the phone is not in use.
2. Press ▼ or ▲ to scroll to **◆Answering sys**, then press **SELECT**.
3. Press ▼ or ▲ to scroll to **◆Ans sys setup**, then press **SELECT**.
4. Press ▼ or ▲ to scroll to **◆Msg alert tone**, then press **SELECT**.
5. Press ▼ or ▲ to select **◆Tone: On** or **◆Tone: Off**.
6. Press **SELECT** to save and you hear a confirmation tone.

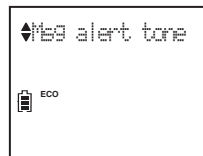

**note**

The answering system must be turned on for message alert tone to beep.

## Message recording time

You can set the recording time allowed for each incoming message. The message length is three minutes by default.

1. Press **MENU** when the phone is not in use.
2. Press ▼ or ▲ to scroll to **◆Answering sys**, then press **SELECT**.
3. Press ▼ or ▲ to scroll to **◆Ans sys setup**, then press **SELECT**.
4. Press ▼ or ▲ to scroll to **◆Recording time**, then press **SELECT**.
5. Press ▼ or ▲ to select **◆3 minutes**, **◆2 minutes** or **◆1 minute**.
6. Press **SELECT** to save and you hear a confirmation tone.

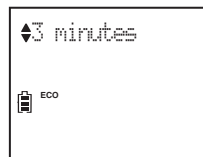

# Answering system operation

## Answering system and voicemail

Your telephone has separate indicators for two different types of voice messages: those left on its built-in digital answering system and those left with your telephone service provider's voicemail (fees may apply). Your telephone's built-in digital answering system messages and voicemail messages are separate. Each alerts you to new messages differently.

- If ►/■/PLAY/STOP on the telephone base flashes, **XX new messages** displays on the handsets and telephone base, there are new messages in the built-in answering system. To listen to the messages recorded on your digital answering system, press ►/■/PLAY on the telephone base (see page 67). To listen to messages with a handset, press **MENU** twice (see page 67).

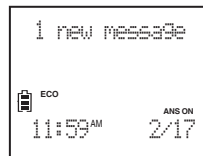

- If ✉ and **New voicemail** display on the handsets and the telephone base, your telephone service provider is indicating that it has new voicemail for you. To listen to your voicemail, press and hold ✉ **1** on your handset/telephone base. See **Voicemail number** on page 26 to set your voicemail number.

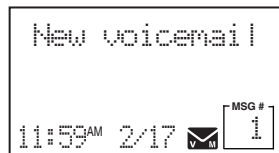

Some telephone service providers bundle or combine multiple services like voicemail and call waiting, so you may not be aware that you have voicemail. To check what services you have and how to access them, contact your telephone service provider.

To use your voicemail service rather than your answering system, turn off your answering system. To use your answering system rather than your voicemail service, contact your telephone service provider to deactivate your voicemail service.



# Answering system operation

## Using the answering system and voicemail together

You can also use your telephone answering system and voicemail together by setting your built-in answering system to answer before voicemail answers as described below. To learn how to program your voicemail settings, contact your telephone service provider. Then, if you are on a call, or if the answering system is busy recording a message and you receive another call, the second caller can leave a voicemail message.

Set your answering system to answer calls at least two rings earlier than your voicemail is set to answer. For example, if your voicemail answers after six rings, set your answering system to answer after four rings. Some voicemail providers may program the delay before answering calls in seconds instead of rings. In this case, allow six seconds per ring when determining the appropriate setting.

## Message capacity

The answering system can record and store up to 59 messages. Each message can be up to three minutes (see page 63 to change). The total storage capacity for the announcement, messages and memos is approximately 14 minutes. The actual recording time depends on individual message characteristics. Messages remain available for replay until you delete them.

## New message indication

The ►/■/PLAY/STOP light on the telephone base flashes, and **XX new messages** displays on the handset and telephone base when there are new answering system messages.

If the message alert tone is turned on, the telephone base beeps every 10 seconds when there are messages that have not been reviewed.

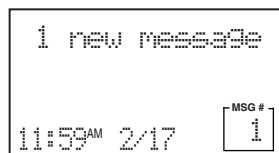

### note

After reviewing all new messages, the total number of messages displays on the telephone base screen.

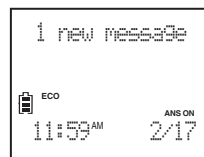

# Answering system operation

## Call screening

### To screen a call at the telephone base:

If the answering system and call screening are on, the announcement and the incoming message broadcast at the telephone base while the call is answered by the answering system.

### Options while a message is being recorded:

- Press ▼ **VOL** or **VOL** ▲ to adjust the call screening volume.
- Press ►/■/STOP or **SELECT** to temporarily silence the call screening.
- Press ►/■/PLAY, **SELECT** or **VOL** ▲ to temporarily turn on the call screening if call screening is set to off.

### To screen a call on a cordless handset:

If the answering system is on, the announcement and the incoming message broadcast at the telephone base when a call is answered by the answering system. At the same time, the cordless handset shows **To screen call press [SELECT]**. Press **SELECT** to screen the call on your cordless handset. The cordless handset shows the caller's information. If you do not subscribe to caller ID service, the cordless handset shows **Screening...**

### Options while a message is being recorded:

- Press ▼/VOLUME or ▲/VOLUME to adjust the call screening volume.
- Press **OFF** to temporarily silence the call screening.
- Press **SELECT** to temporarily turn on the call screening if call screening is set to off.
- Press ◀) to switch between speakerphone mode and handset mode.

## Call intercept

If you want to talk to the caller whose message is being recorded, press 🏠/HOME or ◀) on a cordless handset, or 🏠/HOME on the telephone base, or lift the corded handset from the telephone base.

## Temporarily turn off the message alert tone

If the message alert tone is turned on (see page 63), the telephone base beeps every 10 seconds when there are new messages. Pressing any telephone base key (except 📞 1/ 📞 2, **FIND HANDSET** and 📞/ANS ON/OFF) temporarily silences the message alert tone.

The message alert tone resumes when you receive a new message.

# Answering system operation

## Message playback

When playback begins, the total number of old or new messages is announced. Before each message, you hear the day and time of the recording. If the date and time are not set, you hear, "*Time and date not set,*" before playback. After the last message, you hear, "*End of messages.*" If the recording time is less than three minutes, you hear, "*Less than three minutes to record.*" If there is no remaining recording time, you hear "*Memory is full.*" If there are no recorded messages, the screen shows **No message** and you hear, "*You have no message.*"

### To play messages at the telephone base:

- Press ►/■/PLAY when the phone is not in use.

-OR-

1. Press **MENU** when the phone is not in use.
2. Press **SELECT** to select ↕Play messages. The system plays the messages.

### Options during playback:

- Press ▼ VOL or VOL ▲ to adjust the message playback volume.
- Press ►►/SKIP to skip to the next message.
- Press ◀◀/REPEAT to repeat the message. Press ◀◀/REPEAT twice to hear the previous message.
- Press X/DELETE to delete the playing message. The telephone base displays **Message deleted**. The system announces, "*Message deleted,*" and then advances to the next message.
- Press ►/■/STOP to stop the playback.

### To play messages on a cordless handset:

1. Press **MENU** when the phone is not in use.
2. Press **SELECT** to select ↕Play messages. The system plays the messages.

### Options during playback:

- Press ▼/VOLUME or ▲/VOLUME to adjust the message playback volume.
- Press **6** to skip to the next message.
- Press **4** to repeat the message. Press **4** twice to hear the previous message.
- Press **3** or **DELETE** to delete the playing message. The cordless handset displays **Message deleted**. The system announces, "*Message deleted,*" and then advances to the next message.
- Press **OFF** to stop the playback.
- Press ◀)) to switch between speakerphone mode and handset mode.

# Answering system operation

## Delete all old messages

You can only delete old (reviewed) messages. You cannot delete new messages until you review them. You cannot retrieve deleted messages.

### To delete all old messages at the telephone base:

1. Press **MENU** when the phone is not in use.
2. Press ▼ or ▲ to scroll to **Answering sys**, then press **SELECT**.
3. Press ▼ or ▲ to scroll to **Delete all old**, then press **SELECT**. The screen shows **Delete all msg?**
4. Press **SELECT** again to confirm. You hear a confirmation tone and the system announces, “*All old messages deleted.*” If you do not have old messages, the system announces, “*You have no old message.*”



### To delete all old messages on a cordless handset:

1. Press **MENU** when the phone is not in use.
2. Press ▼ or ▲ to scroll to **Answering sys**, then press **SELECT**.
3. Press ▼ or ▲ to scroll to **Delete all old**, then press **SELECT**. If you do not have old messages, the screen displays **No message**.
4. The screen shows **Delete all msg?** Press **SELECT** again to confirm. The screen displays **Deleting...** then **No old messages**. You hear a confirmation tone.



# Answering system operation

## Record, play and delete memos

Memos are your own recorded messages used as reminders for yourself or others using the same answering system. You can record your own memos using a system handset or the telephone base. Play and delete them in the same way as incoming messages (see **Message playback** on page 67).

### To record a memo:

1. Press **MENU** when the phone is not in use.
2. Press ▼ or ▲ to scroll to **Answering sys**, then press **SELECT**.
3. Press ▼ or ▲ to scroll to **Record memo**, then press **SELECT**.
4. The system announces, "*Record after the tone. Press 5 when you are done.*" After the tone, speak towards the microphone.
5. To stop recording, press **5** on the cordless handset, or press **5** or ►/■/STOP on the telephone base. The system announces, "*Recorded.*"

#### note

- "*Memory is full*" is announced if you record a memo when the memory is full.
- Each memo can be up to three minutes in length.
- Memos shorter than two seconds are not recorded.

# Answering system operation

## Remote access

A two-digit security code is required to access the answering system remotely from any touch-tone telephone. The preset code is **19**. See **Remote access code** on page 62 to change it.

1. Dial your telephone number from any touch-tone telephone.
2. When the system plays your announcement, enter the two-digit remote access code.
3. Then you can enter one of the following remote commands.

Command	Description
<b>1</b>	Play all messages.
<b>2</b>	Play new messages.
<b>3</b>	Delete the current message (during playback).
<b>33</b>	Delete all old messages.
<b>4</b>	Repeat the current message (during playback).
<b>5</b>	Stop.
<b>*5</b>	Hear a list of remote commands.
<b>6</b>	Skip to the next message (during playback).
<b>*7</b>	Record a new announcement.
<b>8</b>	End the call.
<b>0</b>	Turn the answering system on or off.

4. Hang up or press **8** to end the call.

### note

- If you do not press any keys after you enter the remote access code, all new messages play. If there are no new messages, all old messages play.
- Once the new messages have played, the telephone announces the help menu options. If you do not press any key within 20 seconds, the remote access call automatically disconnects.
- When the answering system memory is full, the telephone announces, *"Memory is full. Enter the remote access code."*
- When the answering system is off, the telephone answers after 10 rings, and announces, *"Please enter your remote access code."*

# Appendix

## Expand your telephone system

The cordless handsets provided with your telephone system are already registered as **HANDSET 1** and so forth. Additional handsets registered to the telephone system are assigned numbers in the sequential order. This telephone system accommodates up to five handsets.

You can add new handsets (**DS6601**, purchased separately) to your telephone system. Each handset must be registered with the telephone base before use. When first purchased and properly charged, each expansion handset displays **To register HS...** and **...see manual** alternately. You may need to charge the handset before registering it to the telephone base. For more information on battery charging, see the table on page 4.

## Add and register a handset

When first purchased, each expansion handset alternately shows **To register HS...** and **...see manual**. The new handset should be charged without interruption for at least 30 minutes before registering it to the telephone base.

Make sure the handset is out of the handset charger and is put near the telephone base. Make sure the handset alternately shows **To register HS...** and **...see manual** before you begin registration.

### To register a handset:

1. Press and hold **FIND HANDSET** at the side of the telephone base for about four seconds until the **IN USE** light turns on and it shows **Registering...**
2. Press **QUIET#** on the handset. The handset shows **Registering...** Both the telephone base and cordless handset show **Registered**, and you hear a beep from the handset when the registration process completes. The registration process takes about 60 seconds.

If registration fails, the handset displays **Failed**. Try again the registration process above.



Before registration, make sure the handset is not in the charger.

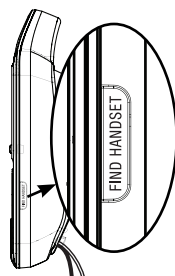

### note

- You cannot register a handset if any other system handset is in use.
- If you have not set the date and time for the telephone system, the handset will prompt you to set the date and time after it is registered to the base. To skip setting, press **CANCEL**.
- You can only register one handset to the telephone base at a time.

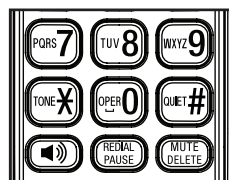

# Appendix

## Replace a handset

If you want to replace a handset, or reassign the designated handset number of a registered handset, you must deregister all handsets that are registered to the telephone base. Then register each handset individually.

To make deregistration easier, read all of the instructions on this page before you begin.

### To deregister all handsets:

1. Press and hold **FIND HANDSET** at the side of the telephone base for about 10 seconds until the telephone base shows **Registering...** then **De-register?** The **IN USE** light flashes.
2. Immediately press and release **SELECT** or **FIND HANDSET**. The telephone base displays **Please wait**.
3. All handsets show **To register HS...** and **...see manual** alternately when the deregistration process completes. The deregistration process takes about 10 seconds.

To register the handset(s) to the telephone base again, follow the registration instructions on the previous page.

#### note

- You cannot deregister all handsets if any other system handset is in use.
- If deregistration fails, you may need to reset the system and try again. To reset, unplug the power from the telephone base and plug it back in.
- Even if the battery is depleted, you can still deregister all handsets by following the steps above. After the handset is charged for at least 10 minutes, its screen alternately shows **To register HS...** and **...see manual**.



# Appendix

## Screen messages

Ans sys off	The answering system is turned off and will not answer calls.
Ans sys on	The answering system is turned on and will answer calls.
Base is calling	The telephone base is calling the handset.
Call log empty	There are no caller ID log entries.
Calling base	The handset is calling the base (for intercom calls). The handset is transferring an outside call to the base.
Calling HS X	The telephone base or another system handset is calling another handset (for intercom calls). The telephone base or another system handset is transferring an outside call to another handset.
Cell line busy	The telephone base or another system handset is using the cell line.
Check AC power	The corded handset is in use while the telephone base is in line power mode.
Contact deleted	A directory entry is deleted.
Directory empty	There are no directory entries.
Directory full	The directory is full. You cannot save any new entries unless you delete some current entries.
Downloading...	The telephone system is downloading the directory from a cell phone.
Ended	You have just ended a call.
Failed	The handset registration is not successful.
HS X is calling	Another system handset is calling (for intercom calls).
Home line busy	The telephone base or another system handset is using the home line.
Incoming call	There is a call coming in.
Intercom	The handset is on an intercom call.
Intercom ended	The intercom call has just ended.
Intercom to (for models with two or more handsets)	You have started the intercom process, and need to enter the device number you wish to call.
Line in use	An extension phone, or one of the handsets is in use.
Low battery	The handset battery needs to be recharged.
Microphone on	The mute function is turned off and the other party can hear you.
Muted	The microphone is off. The other party cannot hear you.
New voicemail	There are new voicemail messages from your telephone service provider.

# Appendix

## Screen messages

NO BATTERY	The handset in the handset charger has no battery installed.
No line	There is no telephone line connection.
Not available	Someone else is using the answering system, directory or caller ID log history. The cell line is not ready to use.
Number repeated	The entry you try to save is already in the directory.
Out of range or no fur at base	The telephone base has lost power, or the handset is out of range.
Pair cell first	You need to pair a cell phone before making a cell call.
Phone	The handset is on a home call.
Put in charger	The battery is very low. The handset should be charged.
Quiet mode on	The telephone system is in quiet mode.
Quiet mode off	The quiet mode is turned off.
Rec mem full	The system recording time is full.
Registered	The handset is successfully registered to the telephone base.
Registering...	The handset is registering to the telephone base.
Ringer muted	The ringer is muted temporarily when the phone is ringing.
Ringer off	The ringer is turned off.
Saved	Your selection has been saved.
Speaker	The handset or base speakerphone is in use.
To register HS... ...see manual	Screen display on a non-registered handset.
Transfer to:	You are transferring an outside call to another cordless handset or the telephone base.
Transferred	You have transferred an outside call to another cordless handset or the telephone base.
Unable to call	The handset is out of range while on a call. Failed phone call (the telephone line is in use). Failed intercom call.
XX missed calls	There are new calls in the caller ID log.
XX new messages	There are new messages in the answering system.
** Paging **	The telephone base is paging all handsets.







# Appendix

## Handset and telephone base indicators

### Handset lights

	On when the handset speakerphone is in use.
<b>CHARGE</b>	On when the handset is charging in the handset charger.









### Telephone base lights

<b>IN USE</b>	On when the telephone line is in use. On when the answering system is answering a call. On when you are registering a handset. Flashes quickly when there is an incoming call. Flashes when another telephone sharing the same line is in use. Flashes when you are deregistering all handsets.
<b>MUTE</b>	On when mute function is on.
 1 /  2	On when a Bluetooth device is connected to the base. Flashes when the telephone base is in discoverable mode.
 /ANS ON/OFF	On when the answering system is turned on.
	On when the home line is using.
	On when the cell line is using.
 /PLAY/STOP	Flashes when there are new memos or messages in the answering system.







# Appendix

## Handset and telephone base indicators

### Handset icons

	The battery icon flashes when the battery is low and needs charging.
	The battery icon animates when the battery is charging.
	The battery icon becomes solid when the battery is fully charged.
	The handset ringer is off.
	The home line is in use or there is an incoming home call.
	There are Bluetooth connected devices on the cell devices list.
	The cell line is in use or there is an incoming cell call.
	There are new voicemail received from your telephone service provider.
<b>ANS ON</b>	The answering system is turned on.
<b>ECO</b>	The ECO mode activates automatically to reduce power consumption when the handset is within range from the telephone base.
<b>NEW</b>	The entry you are reviewing is new in the caller ID log.
	The number of current playing message and the total number of new/old messages recorded.

### Telephone base icons

	The telephone base ringer is off.
	There are new voicemail received from your telephone service provider.
<b>NEW</b>	The entry you are reviewing is new in the caller ID log.
	The total number of messages recorded when the telephone base is not in use. The number of the playing message.
	The home line is in use or there is an incoming home call.
	There are Bluetooth connected devices on the cell devices list.
	The cell line is in use or there is an incoming cell call.

# Appendix

## Handset battery

It takes up to 11 hours for the battery to be fully charged. When it is fully charged, you can expect the following performance:

Operation	Operating time
While in handset use (talking*)	Up to 7 hours
While in speakerphone mode (talking*)	Up to 3.5 hours
While not in use (standby**)	Up to 5 days

\* Operating times vary depending on your actual use and the age of the battery.

\*\* Handset is not charging or in use.

### The battery needs charging when:

- A new battery is installed in the handset.
- The handset beeps.
- A battery is properly installed and the screen is blank.
- **Low battery** or **Put in charger** displays on the handset screen.

### CAUTION:

To reduce the risk of fire or injury, read and follow these instructions:

- Use only the batteries provided or equivalent. To order a replacement, go to [www.vtechphones.com](http://www.vtechphones.com) or call 1 (800) 595-9511. In Canada, go to [www.vtechcanada.com](http://www.vtechcanada.com) or dial 1 (800) 267-7377.
- Do not dispose of the batteries in a fire. Check with local waste management codes for special disposal instructions.
- Do not open or mutilate the batteries. Released electrolyte is corrosive and may cause burns or injury to the eyes or skin. The electrolyte may be toxic if swallowed.
- Exercise care in handling batteries in order not to create a short circuit with conductive materials.
- Charge the batteries provided with or identified for use with this product only in accordance with the instructions and limitations specified in this manual.
- Observe proper polarity orientation between the battery and metallic contacts.
- To prevent fire or shock hazard, do not expose this product to water or any type of moisture.

# Appendix

## Troubleshooting

If you have difficulty with your telephone, please try the suggestions below. For customer service, visit our website at [www.vtechphones.com](http://www.vtechphones.com) or call 1 (800) 595-9511. In Canada, go to [www.vtechcanada.com](http://www.vtechcanada.com) or dial 1 (800) 267-7377.

### I cannot add my cell phone to the telephone base.

- Make sure you have cellular coverage.
- Make sure your cell phone is compatible with your **DS6641**. Check the Bluetooth compatibility list at [www.vtechcanada.com](http://www.vtechcanada.com).
- Make sure the Bluetooth function of your cell phone is turned on. See the user's manual of your cell phone for more information.
- Remove VTech **DS6641** from your cell phone's handsfree device history list (see the user's manual of your cell phone for more information).
- Carefully follow the pairing instructions on page 18 and make sure that your cell phone is not connected to any other Bluetooth device.
- Turn off your cell phone, then turn it on again.
- Reset the telephone base. Unplug the unit's electrical power. Wait for approximately 15 seconds, then plug it back in. Repeat the above suggestions.

### I cannot connect my cell phone with the telephone base.

- Make sure that the Bluetooth function of your cell phone is turned on. See the user's manual of your cell phone for more information.
- Make sure that your Bluetooth cell phone is not connected to any other Bluetooth device.
- Turn off your cell phone, then turn it on again.
- Make sure that your cell phone is connected and active on the cell devices list.
- For some cell phones, you must authorize **VTech DS6641** device in your cell phone's Bluetooth feature. See the user's manual of your cell phone for more information.
- Manually connect your cell phone to **VTech DS6641**. Refer to the user's manual of your cell phone for more information.

### I cannot find VTech DS6641 on my cell phone.

- Make sure that the telephone base is in discoverable mode. Carefully follow the setup instructions on page 18.
- Make sure that you manually set your cell phone to search for devices.
- Remove **VTech DS6641** from your cell phone's handsfree device history list (see the user's manual of your cell phone).
- Turn off your cell phone, then turn it on again.
- Reset the telephone base. Unplug the unit's electrical power. Wait for approximately 15 seconds, then plug it back in. Repeat the above suggestions.

# Appendix

## Troubleshooting

### **I don't know how to search for or add new devices on my cell phone.**

- Most cell phones have the Bluetooth feature in the connection or setup menus. Refer to the user's manual of your cell phone.
- In general, press the menu key on your cell phone, then look for the Bluetooth menu in the settings or connection menu. In the Bluetooth menu, select the option to search for or add new devices.

### **My cell phone disconnects with the telephone base.**

- Turn off your cell phone, then turn it on again.
- Make sure that you are not using your cell phone when on a cell call.

### **My cell phone is connected to the telephone base, but I cannot make a cell call.**

- Make sure that your cell phone is not in use when you are trying to make a cell call.
- For some smartphones, make sure that the cellular function is turned on.

### **The PIN on the telephone base does not work.**

- Make sure you enter the correct PIN. The default PIN is **0000**.

### **I cannot hear any audio on my telephone system when on a cell call.**

- Reset the telephone base. Unplug the unit's electrical power. Wait for approximately 15 seconds, then plug it back in.
- Turn off your cell phone, then turn it on again.

### **I cannot download contacts from my cell phone to the DS6641.**

- Make sure that your cell phone is paired and connected to the base.
- Make sure you place your cell phone next to the base while downloading.

### **Can the DS6641 help the poor cell phone reception in my house?**

- If your cell phone has poor reception in your home, the **DS6641** cannot improve the reception. However, if there is a location in your house with better reception, you can leave your cell phone at that location while you use **DS6641** cell line. In order for this to work, the telephone base must be within 30 feet of the cell phone.

### **The listening volume of my cell call is too loud or quiet.**

- During a cell call, if the listening volume is too loud or quiet, try changing the volume on your cell phone. On some cell phones, changing the volume on the cell phone effects your cell call volume on the **DS6641** handset.

# Appendix

## Troubleshooting

### My telephone doesn't work at all.

- Make sure the power cord is securely plugged in.
- Make sure you plug the battery connector securely into the cordless handset.
- Make sure you plug the telephone line cord securely and firmly into the telephone base and the telephone wall jack.
- Charge the battery in the cordless handset for at least 11 hours. For optimum daily performance, return the cordless handset to the handset charger when not in use.
- If the battery is completely depleted, charge the handset for at least 30 minutes before use (page 4).
- Reset the telephone base. Unplug the electrical power. Wait for approximately 15 seconds, then plug it back in. Allow up to one minute for the cordless handset and telephone base to reset.
- You may need to purchase a new battery. Refer to **Handset battery installation** (page 3) and **Handset battery charging** (page 4).

### I cannot get a dial tone.

- Try all the suggestions above.
- Move the cordless handset closer to the telephone base. You may have moved out of range.
- If the previous suggestions do not work, disconnect the telephone base from the telephone jack and connect to a different phone. If there is no dial tone on that phone either, the problem is in your wiring or telephone service. Contact your telephone service provider.
- Your line cord may be defective. Try installing a new line cord.
- If you have changed your telephone service to digital service from a cable company or a VoIP service provider, the telephone line may need to be rewired to allow all existing telephone jacks to work. Contact your service provider for more information.

### I cannot dial out.

- Try all the suggestions above.
- Make sure you have a dial tone before dialing. The cordless handset may take a second or two to find the telephone base and produce a dial tone. This is normal. Wait an extra second before dialing.
- Eliminate any background noise. Noise from a television, radio or other appliances might cause the phone to not dial out properly. If you cannot eliminate the background noise, first try muting the cordless handset before dialing, or dialing from another room with less background noise.
- If other phones in your home are having the same problem, contact your telephone service provider (charges may apply).
- If you have changed your telephone service to digital service from a cable company or a VoIP service provider, the telephone line may need to be rewired to allow all existing telephone jacks to work. Contact your service provider for more information.



# Appendix

## Troubleshooting

### **My cordless handset isn't performing normally.**

- Make sure you plug the power cord securely into the telephone base. Plug the power adapter into a different, working electrical outlet without a wall switch.
- Move the cordless handset closer to the telephone base. You may have moved out of range.
- Reset the telephone base. Unplug the electrical power. Wait for 15 seconds then plug it back in. Allow up to one minute for the cordless handset and telephone base to reset.
- Other electronic products such as HAM radios and other DECT phones can cause interference with your cordless phone. Try installing your phone as far away as possible from these types of electronic devices.

### **Out of range or no pwr at base appears on my cordless handset.**

- The handset may be out of range. Move it closer to the telephone base.
- Make sure the power cord is securely plugged into the telephone base. Use a working electrical outlet not controlled by a wall switch.
- Reset the telephone by unplugging the power adapter from the telephone base. Disconnect the battery from the cordless handset. Wait for 15 seconds, then plug in the power adapter and install the battery again. Allow up to one minute for the handset and telephone base to synchronize.
- Other electronic products such as HAM radios and other DECT phones can cause interference with your cordless phone. Try installing your phone as far away as possible from these types of electronic devices.

### **The battery does not charge in the handset or the handset battery does not accept charge.**

- If the cordless handset is in the handset charger and the **CHARGE** light is not on, refer to **The CHARGE light is off** (page 83).
- Remove and install the battery again, then charge it for up to 11 hours.
- If the battery is completely depleted, charge the handset for at least 30 minutes before use (page 4).
- You may need to purchase a new battery. Refer to **Handset battery installation** (page 3) and **Handset battery charging** (page 4).

### **I have accidentally set my cordless handset/telephone base LCD language to Spanish or French, and I don't know how to change it back to English.**

- While the handset or the telephone base is not in use, press **MENU**, then enter **✕364#**.
- While the handset is on a call, press **MENU**, then enter **✕364#**. The call ends.

# Appendix

## Troubleshooting

### **I get noise, static, or weak signals even when I'm near the telephone base.**

- If you subscribe to high-speed Internet service (DSL - digital subscriber line) through your telephone line, you must install a DSL filter between the telephone line cord and the telephone wall jack (page 2). The filter prevents noise and caller ID problems as a result of DSL interference. Contact your DSL service provider for more information about DSL filters.
- You may be able to improve the performance of your cordless phone by installing your new telephone base as far as possible from any other existing cordless telephone system that may already be installed.
- Other electronic products such as HAM radios and other DECT phones can cause interference with your cordless phone. Try installing your phone as far away as possible from these types of electronic devices.
- Do not install this phone near a microwave oven or on the same electrical outlet. You may experience decreased performance while the microwave oven is operating.
- If you plug your phone in with a modem or a surge protector, plug the phone (or modem/surge protector) into a different location. If this does not solve the problem, relocate your phone or modem farther apart from one another, or use a different surge protector.
- Relocate your phone to a higher location. The phone may have better reception in a high area.
- If other phones in your home are having the same problem, contact your telephone service provider (charges may apply).

### **I experience poor sound quality when using the handset speakerphone.**

- For increased sound quality while using the handset speakerphone, place the handset on a flat surface with the dialing keys facing up.

### **I hear other calls while using my phone.**

- Disconnect the telephone base from the telephone jack, and plug in a different telephone. If you still hear other calls, contact your telephone service provider.

### **The telephone does not ring when there is an incoming call.**

- Make sure that the ringer is not set to off (page 22).
- Make sure the telephone line cord and power adapter are plugged in properly (page 2)
- The cordless handset may be too far from the telephone base. Move it closer to the telephone base.
- You may have too many extension phones on your telephone line to allow all of them to ring simultaneously. Try unplugging some of them.
- The layout of your home or office might be limiting the operating range. Try moving the telephone base to another location, preferably to a higher location.
- If other phones in your home are having the same problem, contact your telephone service provider (charges may apply).

# Appendix

## Troubleshooting

- Test a working phone at the phone jack. If another phone has the same problem, contact your telephone service provider (charges may apply).
- Other electronic products such as HAM radios and other DECT phones can cause interference with your cordless phone. Try installing your phone as far away as possible from these types of electronic devices.
- Remove and install the battery again. Place the cordless handset in the handset charger. Wait for the cordless handset to reestablish its connection with the telephone base. Allow up to one minute for this to take place.
- Your line cord may be defective. Try installing a new line cord.

### **My calls cut in and out while I'm using my cordless handset.**

- Other electronic products such as HAM radios and other DECT phones can cause interference with your cordless phone. Try installing your phone as far away as possible from these types of electronic devices.
- Do not install this phone near a microwave oven or on the same electrical outlet. You may experience decreased performance while the microwave oven is operating.
- If you plug your phone in with a modem or surge protector, plug the phone (or modem/surge protector) into a different location. If this does not solve the problem, relocate your phone or modem farther apart from one another, or use a different surge protector.
- Relocate your telephone base to a higher location. The phone may have better reception when installed in a high area.
- If other phones in your home are having the same problem, contact your telephone service provider (charges may apply).

### **The CHARGE light is off.**

- Make sure you plug the power and line cords in correctly and securely.
- Unplug the electrical power. Wait for 15 seconds, then plug it back in. Allow up to one minute for the cordless handset and telephone base to reset.
- Clean the charging contacts on the handset and the handset charger each month with a pencil eraser or cloth.

### **The caller ID feature isn't working properly.**

- Caller ID is a subscription service. You must subscribe to this service from your telephone service provider for this feature to work on your phone.
- The caller must be calling from an area that supports caller ID.
- Both your and your caller's telephone service providers must use caller ID compatible equipment.
- If you subscribe to high-speed Internet service (DSL - digital subscriber line) through your telephone line, you must install a DSL filter between the telephone line cord and the telephone wall jack (page 2). The filter prevents noise and caller ID problems resulting from DSL interference. Contact your DSL service provider for more information about DSL filters.

# Appendix

## Troubleshooting

### The telephone does not receive caller ID while on a call.

- Make sure you subscribe to caller ID with call waiting features from your telephone service provider. Caller ID feature works only if both you and the caller are in areas offering caller ID service, and if both telephone service providers use compatible equipment.

### The messages on the answering system are incomplete.

- If a caller leaves a very long message, part of it may be lost when the system disconnects the call after the preset recording time.
- If the caller pauses for too long, the system stops recording and disconnects the call.
- If the memory on the answering system becomes full during a message, the system stops recording and disconnects the call.
- If the caller's voice is very soft, the system may stop recording and disconnect the call.

### The messages are very difficult to hear.

- Press **VOL ▲** on the telephone base or **▲/VOLUME** on the cordless handset to increase the listening volume.

### The answering system does not answer after the correct number of rings.

- Make sure that the answering system is on. **ANS ON** should show on the handset and the **📞/ANS ON/OFF** light on the telephone base should be on.
- If toll saver is activated, the number of rings changes to two when you have new messages stored (page 62).
- If the memory is full or the answering system is off, the system will answer after 10 rings.
- In some cases, the answering system is affected by the ringing system used by your telephone service provider.
- If you subscribe to voicemail service, change the number of rings so that your answering system answers before your voicemail answers. To determine how many rings activate your voicemail, contact your telephone service provider.
- If there is a fax machine connected to the same telephone line, try disconnecting the fax machine. If that solves the problem, consult your fax machine documentation for information on compatibility with answering systems.

# Appendix

## Troubleshooting

### The telephone does not respond to remote commands.

- Make sure to enter your remote access code correctly (page 62).
- Make sure you are calling from a touch-tone phone. When you dial a number, you should hear tones. If you hear clicks, the phone is not a touch-tone telephone and cannot activate the answering system.
- The answering system may not detect the remote access code while your announcement is playing. Try waiting until the announcement is over before entering the code.
- There may be interference on the phone line you are using. Press dialing keys firmly.

### The answering system does not record messages.

- Make sure the answering system is on. **ANS ON** should show on the handset and the **📞/ANS ON/OFF** light on the telephone base should be on.
- When the answering system memory is full, it does not record new messages until some old messages are deleted.
- If you subscribe to voicemail service, change the number of rings so that your answering system answers before your voicemail answers (page 62). To determine how many rings activate your voicemail, contact your telephone service provider.
- If there is a fax machine connected to the same telephone line, try disconnecting the fax machine. If that solves the problem, consult your fax machine documentation for information on compatibility with answering systems.

### The system announces *“Time and day not set.”*

- You need to set the system clock (page 24).

### The outgoing announcement is not clear.

- When you record your announcement, make sure you speak in a normal tone of voice towards the microphone.
- Make sure there is no background noise (TV, music, etc.) while recording.

### New voicemail and show and I don't know why.

- Your telephone has both a built-in answering system and voicemail indication. If **New voicemail** and  appear, then your telephone has received a signal from your telephone service provider that you have a voicemail message waiting for you to retrieve from them. Contact your telephone service provider for more information on how to access your voicemail.

# Appendix

## Troubleshooting

### **I cannot retrieve voicemail messages.**

- Your telephone has both a built-in answering system and voicemail indication. They are independent features and each alerts you to new messages differently. If you subscribe to voicemail service from your telephone service provider, contact your telephone service provider for more information on how to access your voicemail.

### **I subscribe to a nontraditional telephone service that uses my computer to establish connections, and my telephone doesn't work.**

- Make sure your computer is powered on.
- Make sure your Internet connection is working properly.
- Make sure that the software is installed and running for your nontraditional telephone service.
- Make sure to plug your USB telephone adapter into a dedicated USB port on your computer. Do not plug into a multiple port USB hub (USB splitter) that is not powered.
- In a few rare instances, the USB port on your computer may not have enough power. In these instances, try using a USB hub with its own external power supply.
- If you are using a firewall, it may prevent access to your nontraditional telephone service provider. Contact your service provider for more information.

### **Common cure for electronic equipment.**

If the telephone does not respond normally, do the following (in the order listed):

1. Disconnect the power to the telephone base.
2. Disconnect the cordless handset battery.
3. Wait a few minutes.
4. Connect power to the telephone base.
5. Install the battery again, and place the cordless handset into the handset charger.
6. Wait for the cordless handset to reestablish its connection with the telephone base. Allow up to one minute for this to take place.

# Appendix

## Important safety instructions

When using your telephone equipment, basic safety precautions should always be followed to reduce the risk of fire, electric shock and injury, including the following:

1. Read and understand all instructions.
2. Follow all warnings and instructions marked on the product.
3. Unplug this product from the wall outlet before cleaning. Do not use liquid or aerosol cleaners. Use a damp cloth for cleaning.
4. Do not use this product near water such as near a bath tub, wash bowl, kitchen sink, laundry tub or swimming pool, or in a wet basement or shower.
5. Do not place this product on an unstable table, shelf, stand or other unstable surfaces.
6. Slots and openings in the back or bottom of the telephone base and handset are provided for ventilation. To protect them from overheating, these openings must not be blocked by placing the product on a soft surface such as a bed, sofa or rug. This product should never be placed near or over a radiator or heat register. This product should not be placed in any area where proper ventilation is not provided.
7. This product should be operated only from the type of power source indicated on the marking label. If you are not sure of the type of power supply in your home or office, consult your dealer or local power company.
8. Do not allow anything to rest on the power cord. Do not install this product where the cord may be walked on.
9. Never push objects of any kind into this product through the slots in the telephone base or handset because they may touch dangerous voltage points or create a short circuit. Never spill liquid of any kind on the product.
10. To reduce the risk of electric shock, do not disassemble this product, but take it to an authorized service facility. Opening or removing parts of the telephone base or handset other than specified access doors may expose you to dangerous voltages or other risks. Incorrect reassembling can cause electric shock when the product is subsequently used.
11. Do not overload wall outlets and extension cords.
12. Unplug this product from the wall outlet and refer servicing to an authorized service facility under the following conditions:
  - When the power supply cord or plug is damaged or frayed.
  - If liquid has been spilled onto the product.
  - If the product has been exposed to rain or water.
  - If the product does not operate normally by following the operating instructions. Adjust only those controls that are covered by the operation instructions. Improper adjustment of other controls may result in damage and often requires extensive work by an authorized technician to restore the product to normal operation.
  - If the product has been dropped and the telephone base and/or handset has been damaged.
  - If the product exhibits a distinct change in performance.
13. Avoid using a telephone (other than cordless) during an electrical storm. There is a remote risk of electric shock from lightning.
14. Do not use the telephone to report a gas leak in the vicinity of the leak. Under certain circumstances, a spark may be created when the adapter is plugged into the power outlet, or when the handset is replaced in its cradle. This is a common event associated with the closing of any electrical circuit. The user should not plug the phone into a power outlet, and should not put a charged handset into the cradle, if the phone is located in an environment containing concentrations of flammable or flame-supporting gases, unless there is adequate ventilation. A spark in such an environment could create a fire or explosion. Such environments might include: medical use of oxygen without adequate ventilation; industrial gases (cleaning solvents; gasoline vapors; etc.); a leak of natural gas; etc.
15. Only put the handset of your telephone next to your ear when it is in normal talk mode.
16. The power adapters are intended to be correctly oriented in a vertical or floor mount position. The prongs are not designed to hold the plug in place if it is plugged into a ceiling, under-the-table or cabinet outlet.

**SAVE THESE INSTRUCTIONS**

# Appendix

## Precautions for users of implanted cardiac pacemakers

Cardiac pacemakers (applies only to digital cordless telephones):

Wireless Technology Research, LLC (WTR), an independent research entity, led a multidisciplinary evaluation of the interference between portable wireless telephones and implanted cardiac pacemakers. Supported by the U.S. Food and Drug Administration, WTR recommends to physicians that:

### Pacemaker patients





- Should keep wireless telephones at least six inches from the pacemaker.
- Should NOT place wireless telephones directly over the pacemaker, such as in a breast pocket, when it is turned ON.
- Should use the wireless telephone at the ear opposite the pacemaker.

WTR's evaluation did not identify any risk to bystanders with pacemakers from other persons using wireless telephones.

## Operating range

This cordless telephone operates with the maximum power allowed by the Federal Communications Commission (FCC). Even so, this handset and telephone base can communicate over only a certain distance - which can vary with the locations of the telephone base and handset, the weather, and the layout of your home or office.

When the handset is out of range, the handset displays **Out of range or no pwr at base**.

If there is a call while the handset is out of range, it may not ring, or if it does ring, the call may not connect well when you press /HOME or /CELL. Move closer to the telephone base, then press /HOME or /CELL to answer the call.

If the handset moves out of range during a telephone conversation, there may be interference. To improve reception, move closer to the telephone base.

## ECO mode

This power conserving technology reduces power consumption for optimal battery performance. The ECO mode activates automatically whenever the handset is synchronized with the telephone base.



# Appendix

## Maintenance

### Taking care of your telephone

Your telephone contains sophisticated electronic parts, so it must be treated with care.

### Avoid rough treatment

Place the handset down gently. Save the original packing materials to protect your telephone if you ever need to ship it.

### Avoid water

Your telephone can be damaged if it gets wet. Do not use the handset outdoors in the rain, or handle it with wet hands. Do not install the telephone base near a sink, bathtub or shower.

### Electrical storms

Electrical storms can sometimes cause power surges harmful to electronic equipment. For your own safety, take caution when using electrical appliances during storms.

### Cleaning your telephone

Your telephone has a durable plastic casing that should retain its luster for many years. Clean it only with a soft cloth slightly dampened with water or mild soap. Do not use excess water or cleaning solvents of any kind.

Remember that electrical appliances can cause serious injury if used when you are wet or standing in water. If the telephone base should fall into water, DO NOT RETRIEVE IT UNTIL YOU UNPLUG THE POWER CORD AND TELEPHONE LINE CORD FROM THE WALL. Then remove the telephone by the unplugged cords.

# Appendix

## About cordless telephones

- **Privacy:** The same features that make a cordless telephone convenient create some limitations. Telephone calls are transmitted between the telephone base and the cordless handset by radio waves, so there is a possibility that the cordless telephone conversations could be intercepted by radio receiving equipment within range of the cordless handset. For this reason, you should not think of cordless telephone conversations as being as private as those on corded telephones.
- **Electrical power:** The telephone base of this cordless telephone must be connected to a working electrical outlet. The electrical outlet should not be controlled by a wall switch. Calls cannot be made from the cordless handset if the telephone base is unplugged, switched off or if the electrical power is interrupted.
- **Potential TV interference:** Some cordless telephones operate at frequencies that may cause interference to televisions and VCRs. To minimize or prevent such interference, do not place the telephone base of the cordless telephone near or on top of a TV or VCR. If interference is experienced, moving the cordless telephone farther away from the TV or VCR often reduces or eliminates the interference.
- **Rechargeable batteries:** Exercise care in handling batteries in order not to create a short circuit with conducting material such as rings, bracelets and keys. The battery or conductor may overheat and cause harm. Observe proper polarity between the battery and the battery charger.
- **Nickel-metal hydride rechargeable batteries:** Dispose of these batteries in a safe manner. Do not burn or puncture the battery. Like other batteries of this type, if burned or punctured, they could release caustic material which could cause injury.

## The RBRC® seal

The RBRC® seal on the nickel-metal hydride battery indicates that VTech Communications, Inc. is voluntarily participating in an industry program to collect and recycle these batteries at the end of their useful lives, when taken out of service within the United States and Canada.

The RBRC® program provides a convenient alternative to placing used nickel-metal hydride batteries into the trash or municipal waste, which may be illegal in your area.

VTech's participation in RBRC® makes it easy for you to drop off the spent battery at local retailers participating in the RBRC® program or at authorized VTech product service centers. Please call **1 (800) 8 BATTERY™** for information on Ni-MH battery recycling and disposal bans/restrictions in your area. VTech's involvement in this program is part of its commitment to protecting our environment and conserving natural resources.

**RBRC® is a registered trademark of Rechargeable Battery Recycling Corporation.**



# Appendix

## Limited warranty

### What does this limited warranty cover?

The manufacturer of this VTech Product warrants to the holder of a valid proof of purchase (“Consumer” or “you”) that the Product and all accessories provided in the sales package (“Product”) are free from defects in material and workmanship, pursuant to the following terms and conditions, when installed and used normally and in accordance with the Product operating instructions. This limited warranty extends only to the Consumer for Products purchased and used in the United States of America and Canada.

### What will VTech do if the Product is not free from defects in materials and workmanship during the limited warranty period (“Materially Defective Product”)?

During the limited warranty period, VTech’s authorized service representative will repair or replace at VTech’s option, without charge, a Materially Defective Product. If we repair the Product, we may use new or refurbished replacement parts. If we choose to replace the Product, we may replace it with a new or refurbished Product of the same or similar design. We will retain defective parts, modules, or equipment. Repair or replacement of the Product, at VTech’s option, is your exclusive remedy. VTech will return the repaired or replacement Products to you in working condition. You should expect the repair or replacement to take approximately 30 days.

### How long is the limited warranty period?

The limited warranty period for the Product extends for ONE (1) YEAR from the date of purchase. If VTech repairs or replaces a Materially Defective Product under the terms of this limited warranty, this limited warranty also applies to repaired or replacement Product for a period of either (a) 90 days from the date the repaired or replacement Product is shipped to you or (b) the time remaining on the original one-year warranty; whichever is longer.

### What is not covered by this limited warranty?

This limited warranty does not cover:

1. Product that has been subjected to misuse, accident, shipping or other physical damage, improper installation, abnormal operation or handling, neglect, inundation, fire, water or other liquid intrusion; or
2. Product that has been damaged due to repair, alteration or modification by anyone other than an authorized service representative of VTech; or
3. Product to the extent that the problem experienced is caused by signal conditions, network reliability, or cable or antenna systems; or
4. Product to the extent that the problem is caused by use with non-VTech accessories; or
5. Product whose warranty/quality stickers, product serial number plates or electronic serial numbers have been removed, altered or rendered illegible; or
6. Product purchased, used, serviced, or shipped for repair from outside the United States of America or Canada, or used for commercial or institutional purposes (including but not limited to Products used for rental purposes); or
7. Product returned without a valid proof of purchase (see item 2 on the next page); or
8. Charges for installation or set up, adjustment of customer controls, and installation or repair of systems outside the unit.

# Appendix

## Limited warranty

### How do you get warranty service?

To obtain warranty service in the USA, please visit our website at [www.vtechphones.com](http://www.vtechphones.com) or call 1 (800) 595-9511. In Canada, go to [www.vtechcanada.com](http://www.vtechcanada.com) or dial 1 (800) 267-7377.

**NOTE:** Before calling for service, please review the user's manual - a check of the Product's controls and features may save you a service call.

Except as provided by applicable law, you assume the risk of loss or damage during transit and transportation and are responsible for delivery or handling charges incurred in the transport of the Product(s) to the service location. VTech will return repaired or replaced Product under this limited warranty. Transportation, delivery or handling charges are prepaid. VTech assumes no risk for damage or loss of the Product in transit. If the Product failure is not covered by this limited warranty, or proof of purchase does not meet the terms of this limited warranty, VTech will notify you and will request that you authorize the cost of repair prior to any further repair activity. You must pay for the cost of repair and return shipping costs for the repair of Products that are not covered by this limited warranty.

### What must you return with the Product to get warranty service?

1. Return the entire original package and contents including the Product to the VTech service location along with a description of the malfunction or difficulty; and
2. Include a "valid proof of purchase" (sales receipt) identifying the Product purchased (Product model) and the date of purchase or receipt; and
3. Provide your name, complete and correct mailing address, and telephone number.

### Other limitations

This warranty is the complete and exclusive agreement between you and VTech. It supersedes all other written or oral communications related to this Product. VTech provides no other warranties for this Product. The warranty exclusively describes all of VTech's responsibilities regarding the Product. There are no other express warranties. No one is authorized to make modifications to this limited warranty and you should not rely on any such modification.

**State/Provincial Law Rights:** This warranty gives you specific legal rights, and you may also have other rights, which vary from state to state or province to province.

**Limitations:** Implied warranties, including those of fitness for a particular purpose and merchantability (an unwritten warranty that the Product is fit for ordinary use) are limited to one year from the date of purchase. Some states/provinces do not allow limitations on how long an implied warranty lasts, so the above limitation may not apply to you. In no event shall VTech be liable for any indirect, special, incidental, consequential, or similar damages (including, but not limited to lost profits or revenue, inability to use the Product or other associated equipment, the cost of substitute equipment, and claims by third parties) resulting from the use of this Product. Some states/provinces do not allow the exclusion or limitation of incidental or consequential damages, so the above limitation or exclusion may not apply to you.

**Please retain your original sales receipt as proof of purchase.**

# Appendix

## FCC, ACTA and IC regulations

### FCC Part 15

This equipment has been tested and found to comply with the requirements for a Class B digital device under Part 15 of the Federal Communications Commission (FCC) rules. These requirements are intended to provide reasonable protection against harmful interference in a residential installation. This equipment generates, uses and can radiate radio frequency energy and, if not installed and used in accordance with the instructions, may cause harmful interference to radio communications. However, there is no guarantee that interference will not occur in a particular installation. If this equipment does cause harmful interference to radio or television reception, which can be determined by turning the equipment off and on, the user is encouraged to try to correct the interference by one or more of the following measures:

- Reorient or relocate the receiving antenna.
- Increase the separation between the equipment and receiver.
- Connect the equipment into an outlet on a circuit different from that to which the receiver is connected.
- Consult the dealer or an experienced radio/TV technician for help.

Changes or modifications to this equipment not expressly approved by the party responsible for compliance could void the user's authority to operate the equipment.

This device complies with Part 15 of the FCC rules. Operation is subject to the following two conditions: (1) this device may not cause harmful interference, and (2) this device must accept any interference received, including interference that may cause undesired operation. Privacy of communications may not be ensured when using this telephone.

To ensure safety of users, the FCC has established criteria for the amount of radio frequency energy that can be safely absorbed by a user or bystander according to the intended usage of the product. This product has been tested and found to comply with the FCC criteria. The handset may be safely held against the ear of the user. The telephone base shall be installed and used such that parts of the user's body other than the hands are maintained at a distance of approximately 20 cm (8 inches) or more.

This Class B digital apparatus complies with Canadian ICES-003.

### FCC Part 68 and ACTA

This equipment complies with Part 68 of the FCC rules and with technical requirements adopted by the Administrative Council for Terminal Attachments (ACTA). The label on the back or bottom of this equipment contains, among other things, a product identifier in the format US:AAAEQ##TXXXX. This identifier must be provided to your telephone service provider upon request.

The plug and jack used to connect this equipment to premises wiring and the telephone network must comply with applicable Part 68 rules and technical requirements adopted by ACTA. A compliant telephone cord and modular plug is provided with this product. It is designed to be connected to a compatible modular jack that is also compliant. An RJ11 jack should normally be used for connecting to a single line and an RJ14 jack for two lines. See the installation instructions in the user's manual.

The Ringer Equivalence Number (REN) is used to determine how many devices you may connect to your telephone line and still have them ring when you are called. The REN for this product is encoded as the 6th and 7th characters following the US: in the product identifier (e.g., if ## is 03, the REN is 0.3). In most, but not all areas, the sum of all RENs should be five (5.0) or less. For more information, contact your telephone service provider.

This equipment may not be used with Party Lines. If you have specially wired alarm dialing equipment connected to your telephone line, ensure the connection of this equipment does not disable your alarm equipment. If you have questions about what will disable alarm equipment, consult your telephone service provider or a qualified installer.

If this equipment is malfunctioning, it must be unplugged from the modular jack until the problem has been corrected. Repairs to this telephone equipment can only be made by the manufacturer or its authorized agents. For repair procedures, follow the instructions outlined under the **Limited warranty**.

# Appendix

## FCC, ACTA and IC regulations

If this equipment is causing harm to the telephone network, the telephone service provider may temporarily discontinue your telephone service. The telephone service provider is required to notify you before interrupting service. If advance notice is not practical, you will be notified as soon as possible. You will be given the opportunity to correct the problem and the telephone service provider is required to inform you of your right to file a complaint with the FCC. Your telephone service provider may make changes in its facilities, equipment, operation, or procedures that could affect the proper functioning of this product. The telephone service provider is required to notify you if such changes are planned.

If this product is equipped with a corded or cordless handset, it is hearing aid compatible.

If this product has memory dialing locations, you may choose to store emergency telephone numbers (e.g., police, fire, medical) in these locations. If you do store or test emergency numbers, please:

Remain on the line and briefly explain the reason for the call before hanging up.

Perform such activities in off-peak hours, such as early morning or late evening.

### Industry Canada

Operation is subject to the following two conditions: (1) this device may not cause harmful interference, and (2) this device must accept any interference, including interference that may cause undesired operation.

The term "IC:" before the certification/registration number only signifies that the Industry Canada technical specifications were met.

The Ringer Equivalence Number (REN) for this terminal equipment is 1.0. The REN is an indication of the maximum number of devices allowed to be connected to a telephone interface. The termination on an interface may consist of any combination of devices subject only to the requirement that the sum of the RENs of all the devices does not exceed five.

This product meets the applicable Industry Canada technical specifications.

# Appendix

## Technical specifications

Frequency control	Crystal controlled PLL synthesizer
Transmit frequency	DECT frequency: 1921.536-1928.448 MHz Bluetooth frequency: 2402.000-2480.000 MHz
Channels	DECT channel: 5 Bluetooth channel: 79
Nominal effective range	Maximum power allowed by FCC and IC. Actual operating range may vary according to environmental conditions at the time of use.
Power requirements	Handset: 2.4V Ni-MH battery Telephone base: 6V DC @ 400mA Charger: 6V AC @ 300mA
Memory	Directory: 200 memory locations; up to 30 digits and 15 characters Caller ID log: 50 memory locations; up to 24 digits and 15 characters

# Index

## A

- About cordless telephones 90
- Add a cell phone 18
- Add a directory entry 46
- Add a handset 71
- Alphabetical search 48
- Announcement 59–60
- Answer a call 30, 32
- Answering system 59–70
- Answer on/off 61
- Assign a speed dial number 51

## B

- Base layout 9–11
- Battery 3, 4, 77
- Bluetooth 14–20
- Bluetooth glossary 16
- Bluetooth setup 17

## C

- Call intercept 66
- Call screening 62, 66
- Call transfer 39
- Call waiting 31, 33
- Caller ID 53–58
- Cardiac pacemakers 88
- Cell phone - download directory 20
- Chain dialing 38
- Charger installation 2
- Charge the battery 4
- Clock 24

## D

- Date and time 24
- Delete a call log entry 57
- Delete a directory entry 50
- Delete a speed dial number 52
- Delete messages 67, 68
- Delete the announcement 60
- Deregister handsets 72
- Dial a caller ID log entry 56
- Dial a directory entry 49
- Dial a speed dial number 52
- Dialing options 56
- Dial mode 28
- Directory 20, 45–52
- Download directory 20
- DSL filter 2

## E

- ECO mode 88
- Edit a directory entry 49
- End a call 31, 33
- Expand your telephone system 71

## F

- FCC, ACTA and IC regulations 93–94
- Find handset 40
- Flash 31, 33

## H

- Handset battery installation 3
- Handset icons 76
- Handset layout 12–13
- Handset lights 75
- Handset locator 40
- Home area code 28

## I

- Icons 76
- Important safety instructions 87
- Installation 2, 3, 5–7
- Intercom 42–44

## J

- Join a call 41

## K

- Key tone 27

## L

- Language 25
- Lights 75
- Limited warranty 91–92

## M

- Maintenance 89
- Make a call 30, 31
- Memo 69
- Menu 21
- Message alert tone 63, 66
- Message capacity 65
- Message playback 67
- Missed call indicator 55
- Mute 35

## N

- Number of rings 62



# Index

## O

- Operating range 88
- Operation 30–40, 64–70

## P

- Parts checklist 1
- Play the announcement 60
- Precautions for users of implanted cardiac pacemakers 88
- Predial 30, 32
- Pulse dialing 37

## Q

- Quiet mode 29

## R

- Reassign a speed dial number 51
- Record an announcement 59
- Recording time 63
- Redial 36
- Register a handset 71
- Remote access 70
- Remote access code 62
- Replace a handset 72
- Review directory entries 48
- Review the caller ID log 55
- Ringer silencing 35
- Ringer tone 23
- Ringer volume 22

## S

- Safety instructions 87
- Save a caller ID log entry 57
- Screen messages 58, 73–74
- Settings 21–29, 59–63
- Share a call 41
- Speakerphone 34
- Speed dial 51–52

## T

- Tabletop 7
- Technical specifications 95
- Telephone base icons 76
- Telephone base installation 2
- Telephone base layout 9–11
- Telephone base lights 75
- Temporary ringer silencing 35
- Temporary tone dialing 37
- Tone 23, 27, 63, 66
- Tone dialing 37
- Transfer a call 39
- Troubleshooting 78–86

## U

- Using the menu 21

## V

- Voicemail 26, 27, 33, 38, 64
- Voicemail indicators 27
- Volume 22, 34, 60, 66, 67

## W

- Wall mount 5–6
- Warranty 91–92
- Website 40

VTECH TELECOMMUNICATIONS LTD.  
A member of THE VTECH GROUP OF COMPANIES.  
VTech is the registered trademark of VTech Holdings Limited.  
Copyright © 2013 for VTECH TELECOMMUNICATIONS LTD.  
All rights reserved. Version 2 01/13.

91-006367-010-100

**vtech**<sup>®</sup>